



ARCH CLOTHES VALET

TECHNISCHES BLATT
SCHEDA TECNICA
DATA SHEET
FICHE TECHNIQUE

ARCH CLOTHES VALET

DESIGN FRONT, 2014



Stummer Diener aus zweifarbigem Buchenbugholz: in Schwarz und Buche Natur.

Servomuto in faggio curvato bicolore: nero e faggio naturale.

Two-tone bent beech-wood clothes valet: black and natural beech.

Valet en hêtre cintré bicolore: noir et hêtre naturel.

Galán de noche de haya curvada bicolore: en negro y haya natural.



CHVALELGN

Dimensions mm.

height 1070 | width 460 | depth 260

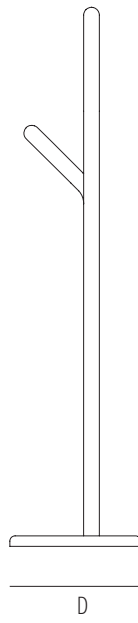
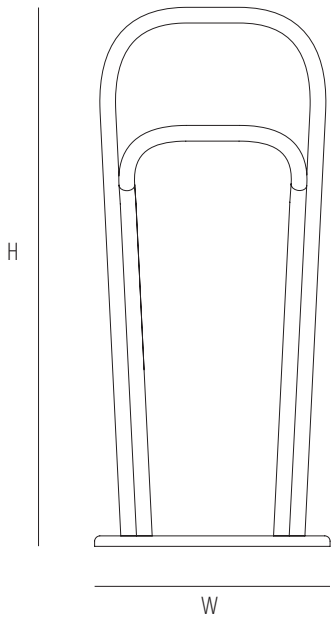

	H	W	D	TH	AH
mm	1070	460	260		
inch	42,1	18,1	10,2		

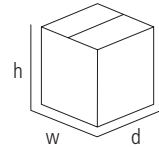
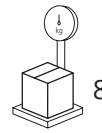
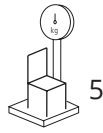
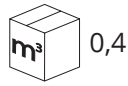
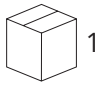

mm - inch
 h 1200 - 47,2
 w 730 - 28,7
 d 450 - 17,7

Verfuegbare Ausfuehrungen
Finiture disponibili
Available finishes
Finitions disponibles

STRUCTURE 1 STRUCTURE 2

B01	C01
C01	B01

SOLID WOOD / ESSENZE NATURALI



B01 BEECH
B01 FAGGIO

CLASSIC LACQUER / LACCATO CLASSICO



C01 - RAL 9005 BLACK

Gebrüder Thonet Vienna GmbH
Prinz Eugen Straße 42
1040 Wien (AT)

www.gebruederthonetvienna.com

Offices of the trademarks' licensee
Production Furniture International S.p.A.
Via Foggia, 23/H
10152 Torino (TO) Italy

Phone: 0039 011 0133330 - info@gebruederthonetvienna.com