



N.0

TECHNISCHES BLATT  
SCHEDA TECNICA  
DATA SHEET  
FICHE TECHNIQUE

# N.O

DESIGN FRONT, 2017



Stuhl mit einer Armlehne aus Buchenbugholz. Gepolsterter Sitz und Rückenlehne aus Wiener Geflecht oder technischem Netz. Auch erhältlich mit 2 Armlehnen oder ohne Armlehnen.

Sedia con un bracciolo in faggio curvato. Sedile imbottito e schienale in paglia di Vienna o in rete tecnica. Disponibile anche con 2 braccioli o senza

Bent beech-wood chair with one armrest. Upholstered seat and back in woven cane or technical net. Also available with 2 armrests or without armrests.

Chaise avec un accoudoir en hêtre cintré. Assise rembourrée et dossier en paille de Vienne ou en résille technique. Egalement disponible avec 2 accoudoirs ou sans accoudoirs.

Silla con un brazo en haya curvada. Asiento y respaldo tapizados en paja de Viena o malla técnica. También disponible con 2 reposabrazos o sin ellos.



**SDZEROTES**

Dimensions mm.

height 870 | width 480 | depth 515



**SDZEROTEX**

Dimensions mm.

height 870 | width 525 | depth 515

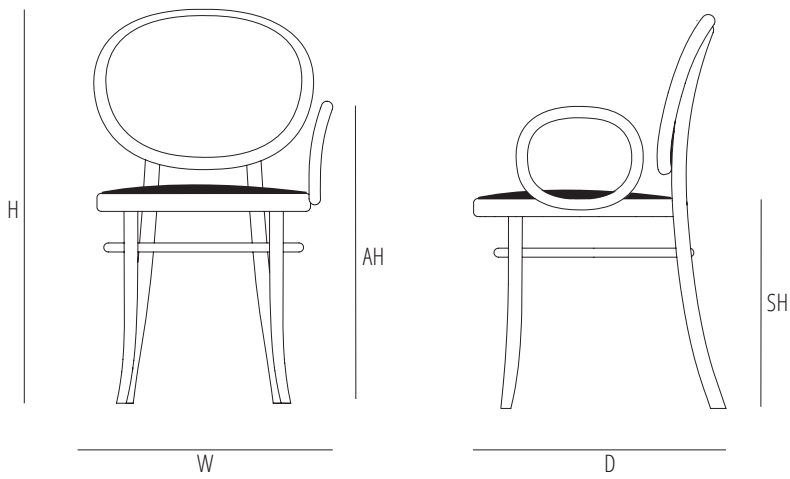

	H	W	D	SH	AH	
mm	870	525	515	470	650	1 Pz/Pc: 65 cm. Linear x 140 cm h/width
inch	34,3	20,6	20,2	18,5	25,5	2 Pz/Pc: 65 cm. Linear x 140 cm h/width

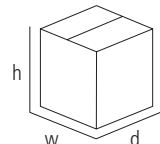
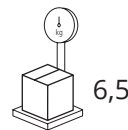
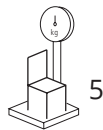
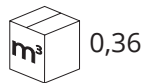
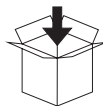
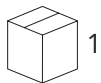

mm - inch  
h 960 - 37,7  
w 620 - 24,4  
d 600 - 23,6

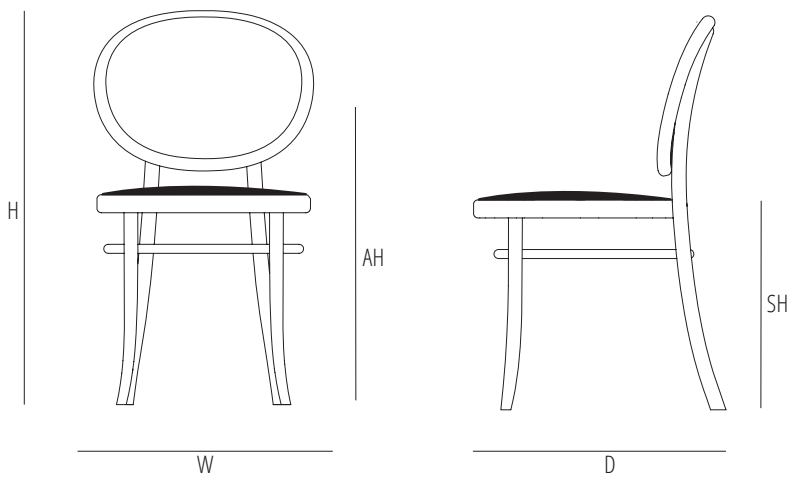

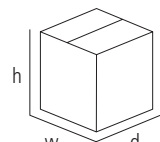
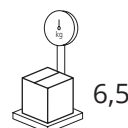
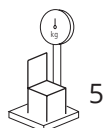
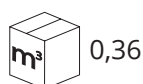
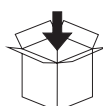
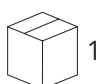

	H	W	D	SH	AH	
mm	870	480	515			1 Pz/Pc: 65 cm. Linear x 140 cm h/width
inch	34,3	18,9	20,2			2 Pz/Pc: 65 cm. Linear x 140 cm h/width

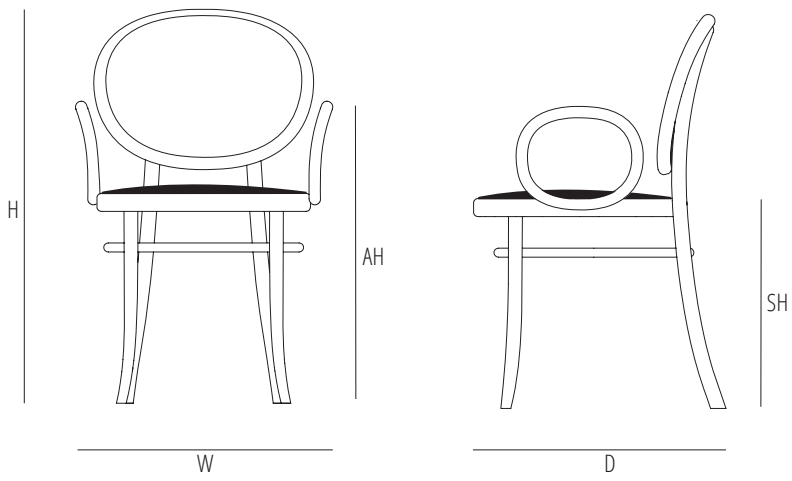

mm - inch  
h 960 - 37,7  
w 620 - 24,4  
d 600 - 23,6

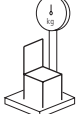
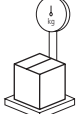
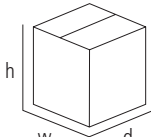

	H	W	D	SH	AH	
mm	870	570	515	470	650	1 Pz/Pc: 65 cm. Linear x 140 cm h/width
inch	34,3	22,5	20,2	18,5	25,5	2 Pz/Pc: 65 cm. Linear x 140 cm h/width

 1
  max. 2
  0,36
  5
  6,5
 

mm - inch  
 h 960 - 37,7  
 w 620 - 24,4  
 d 600 - 23,6

Verfuegbare Ausfuehrungen  
Finiture disponibili  
Available finishes  
Finitions disponibles

SOLID WOOD / ESSENZE NATURALI



B01 BEECH  
B01 FAGGIO

STAINS / TINTI



B03 DARK WALNUT  
B03 NOCE SCURO



B04 WENGÈ  
B04 WENGÈ



B08 BEECH-WOOD STAINED IN NOCE CANALETTO  
B08 FAGGIO TINTO NOCE CANALETTO

CLASSIC LACQUER / LACCATO CLASSICO



C01 - RAL 9005 BLACK

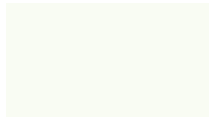

C02 - RAL 9010 PURE WHITE

CONTEMPORARY LACQUER / LACCATO CONTEMPORANEO



D01 - RAL 1013 PEARL WHITE



D02 - RAL 7047 TELEGREY 4



D03 - RAL 7030 STONE GREY



D19 - S7502 G DARK GREY



D21 - S1510 Y80R POWDER PINK



D29 - S3060 Y60R RED ORANGE



D26 - S3560 Y80R CARMINE RED



D14 - RAL 3005 WINE RED



D30 - S3030 B PASTEL BLUE



D11 - RAL 7000 SQUIRREL GREY



D12 - RAL 7031 BLUE GREY



D25 - RAL 5011 STEEL BLUE



D15 - RAL 5020 OCEAN BLUE



D27 - S1050 Y10R MELON YELLOW



D28 - S2050 G90Y CAMPUS GREEN



D23 - S6020 G10Y DARK GREEN

Gebrüder Thonet Vienna GmbH  
Prinz Eugen Straße 42  
1040 Wien (AT)

**[www.gebruederthonetvienna.com](http://www.gebruederthonetvienna.com)**

Offices of the trademarks' licensee  
Production Furniture International S.p.A.  
Via Foggia, 23/H  
10152 Torino (TO) Italy

Phone: 0039 011 0133330 - [info@gebruederthonetvienna.com](mailto:info@gebruederthonetvienna.com)