

# LEMA JOURNAL NEW STORIES

APRIL '23

**LEMA**

LEARN MORE ON [LEMAMOBILI.COM](https://www.lemamobili.com)

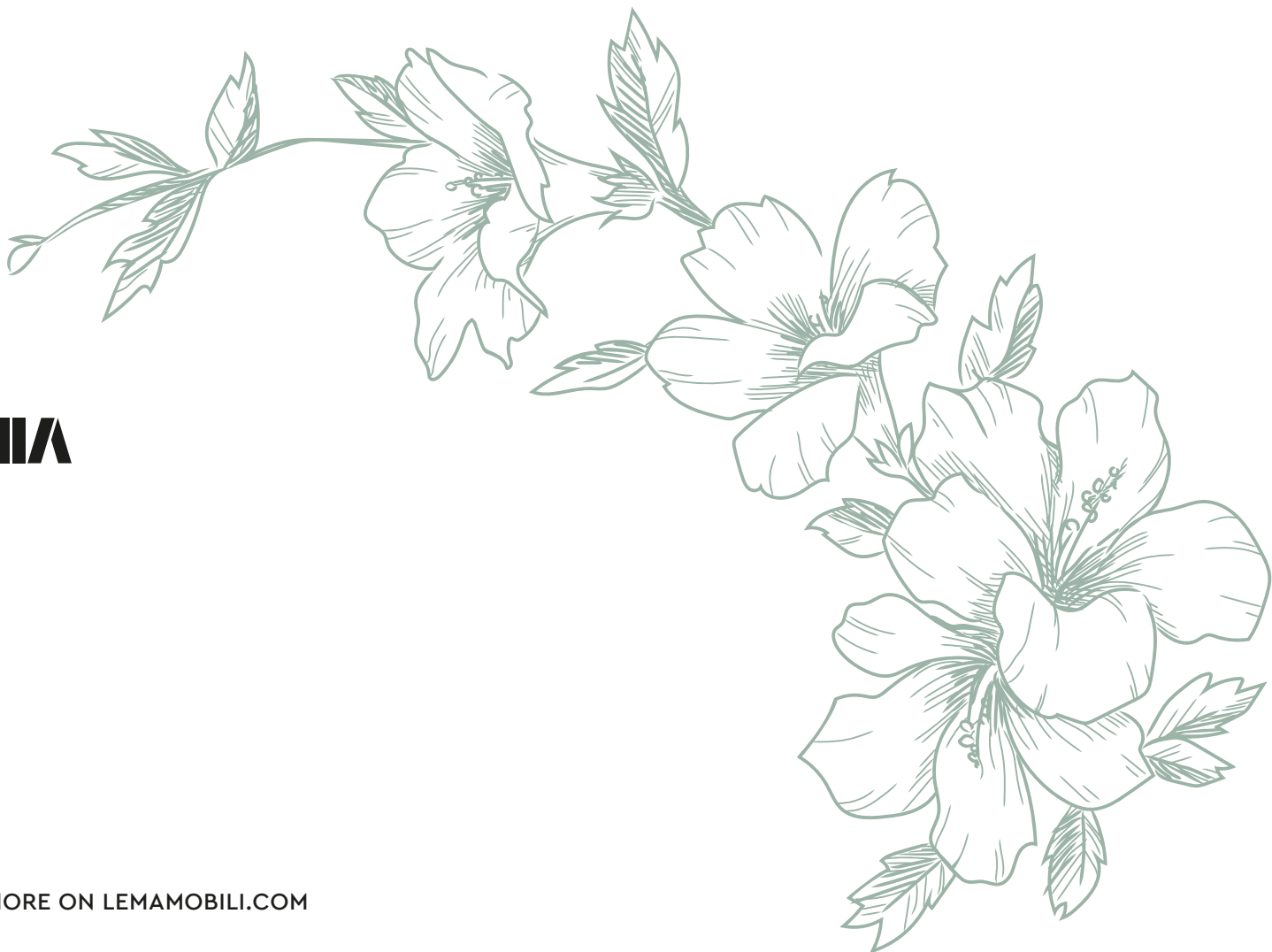

The Lema factory in Alzate  
Brianza designed by  
Angelo Mangiarotti



LEMA  
JOURNAL  
NEW  
STORIES  
EDITION '23

Soffio — p. 6  
Lullaby — p. 12  
Lina — p. 20  
Ayra — p. 24  
Drum — p. 28  
Niveaux — p. 32  
VentiTre — p. 36  
Lena — p. 40

LEMA

**IT** Un racconto che fiorisce svelando un delicato universo creativo di petalo in petalo. La collezione 2023 di Lema esprime una'idea di convivialità la cui cifra stilistica risiede nell'incontro tra atmosfere rilassate e accoglienti. La cura per il dettaglio e la costante sperimentazione intorno alla scelta di colori, materiali e soprattutto le loro combinazioni, danno vita ad arredi dove il design delle forme incontra la ricercatezza delle finiture. Interpretazioni uniche e contemporanee di uno stile di vita, quello mediterraneo, essenza del made in Italy, che si apre al mondo. La casa Lema è un luogo dove il design entra in punta di piedi, un rifugio personale dall'atmosfera vissuta, che favorisce la tranquillità e la condivisione delle emozioni.

**EN** A story that flourishes from petal to petal revealing an indulgent creative universe. Lema's 2023 collection expresses an idea of conviviality where the stylistic hallmark are an encounter between relaxing and welcoming atmospheres. Attention to detail and constant research regarding choice of colours, materials and their combinations give life to furnishings where the design of the shapes meets the refinement of the finishes. A unique and contemporary interpretation of a lifestyle, the Mediterranean one, the essence of made in Italy, presented to the world. The Lema house is a place where design enters discreetly, a personal refuge with a convivial atmosphere, favouring tranquillity and sharing of emotions.

**IT** Soffio è un sistema di sedute interamente ecosostenibile, frutto di un lungo percorso progettuale che ha dato vita ad un prodotto unico: tutte le sue componenti sono concepite per essere facilmente disassemblabili e correttamente smaltite alla fine del suo ciclo di vita.

**EN** Soffio is an entirely eco-friendly seating system, resulting from a long design process that has created a unique product: all its components are designed to be easily disassembled and correctly recycled at the end of their life cycle.

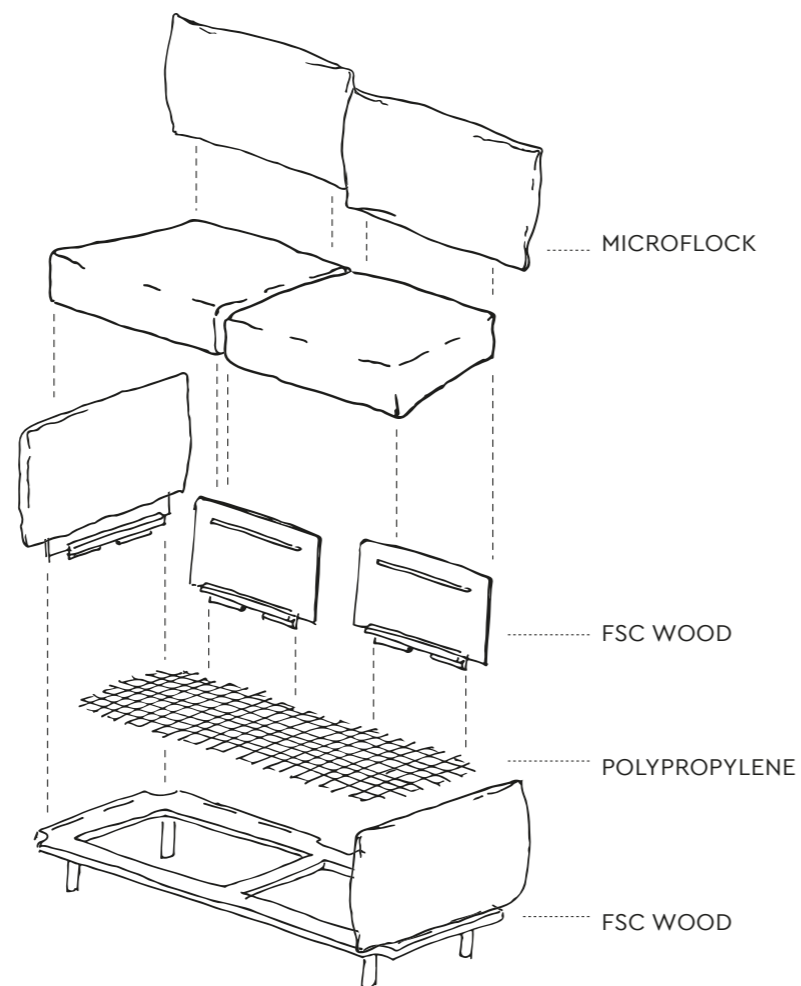

# SOFFIO

## Sofa+Armchair





**IT** Una sottile ma solida base in legno accoglie e sostiene la cuscineria dello schienale e della seduta dai volumi morbidi e generosi. Il rivestimento, in tela di cotone al 100%, racchiude un'imbottitura in fibra riciclata.

**EN** A thin yet solid wooden base welcomes and supports the backrest and seat cushions with soft and generous volumes. The cover, in 100% cotton canvas, encloses a recycled fibre padding.

**IT** La varietà degli elementi disponibili di divano e poltrona Soffio permette di realizzare composizioni aperte, dal carattere fresco ed informale che invita al relax e a vivere momenti di spensierata convivialità. Arredo dall'aspetto classico, Soffio è una risposta concreta alle esigenze dell'abitare contemporaneo, con uno sguardo attento alla sostenibilità.

**EN** The variety of elements of Soffio sofa and armchair allows you to create open compositions. With a fresh and informal character inviting you to relax and experience moments of carefree relax. A furnishing with a classic look, Soffio is a concrete response to the needs of contemporary living, with a careful eye on sustainability.

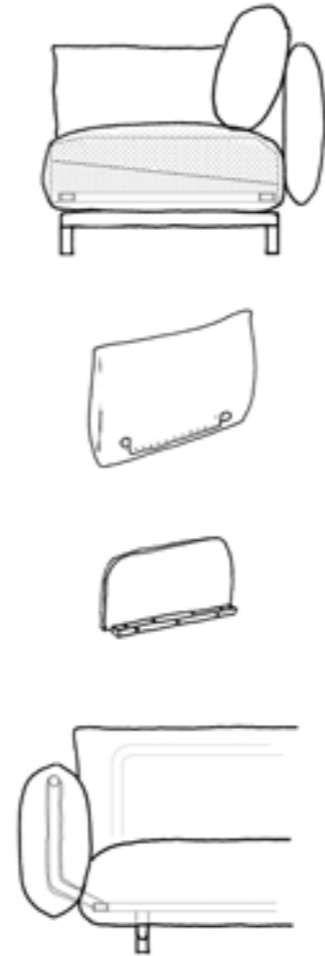

**IT** La collezione Lullaby è una famiglia di contenitori per la zona notte, dalle forme gentili e armoniose, dove i volumi pieni sono addolciti dagli angoli smussati. In un'atmosfera sofisticata che rende il relax e la funzionalità protagonisti, trovano il loro habitat naturale il letto e il gruppo notte composto da cassettera e comodini.

**EN** The Lullaby collection is a family of containers for the night area, with gentle and harmonious shapes. The full volumes are softened by the rounded corners. In a sophisticated atmosphere where relaxation and functionality are the protagonists, the bed and night group, made up of a chest of drawers and nightstands, find their natural habitat.

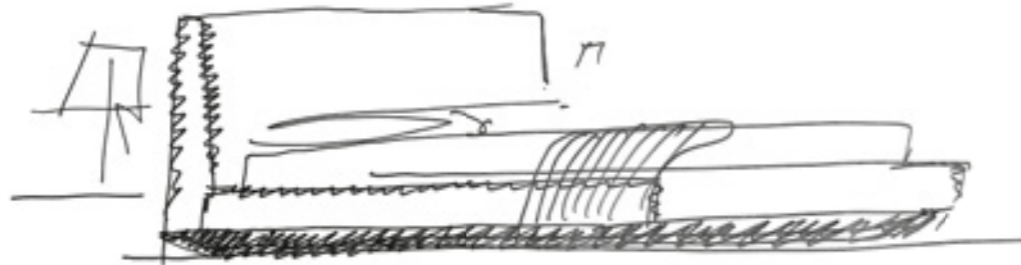

# LULLABY

Bed+Bedroom containers



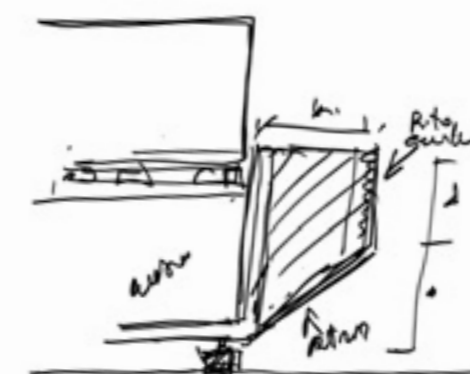
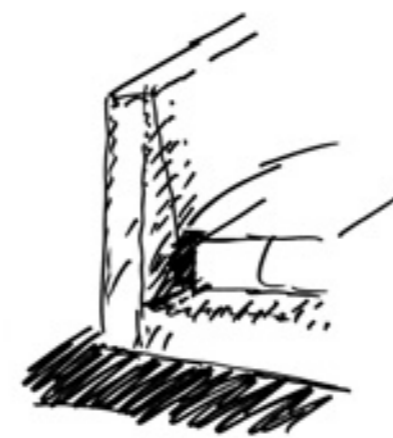

**IT** Il letto Lullaby, disponibile anche con vano contenitore, rappresenta il punto di arrivo di una profonda esperienza sulla lavorazione tessile, in particolare modo delle cuciture a punto cavallo. La testata alta e imponente conferisce alla figura una forte impronta geometrica e un effetto morbido e avvolgente, esaltato dalle imbottiture. La vera innovazione di questo progetto riguarda il design del giroletto, dal discreto impatto visivo.

**EN** The Lullaby bed, also available with storage compartment, represents the culmination of profound experience in textile manufacturing, especially stitching. The high and imposing headboard gives a strong geometric imprint and a soft and enveloping effect, which is further enhanced by the padding. The real innovation of this project concerns the design of the bed frame, with a discreet visual impact.



**IT** La leggerezza e l'equilibrio delle forme arrotondate sono la cifra stilistica della famiglia di contenitori notte della collezione Lullaby. Una proposta funzionale che non rinuncia ad un fascino senza tempo.

**EN** The lightness and equilibrium of the rounded shapes are the stylistic hallmark of the group of night containers in the Lullaby collection. A functional proposal that does not give up a timeless charm.



# FINISHINGS

## Proposals

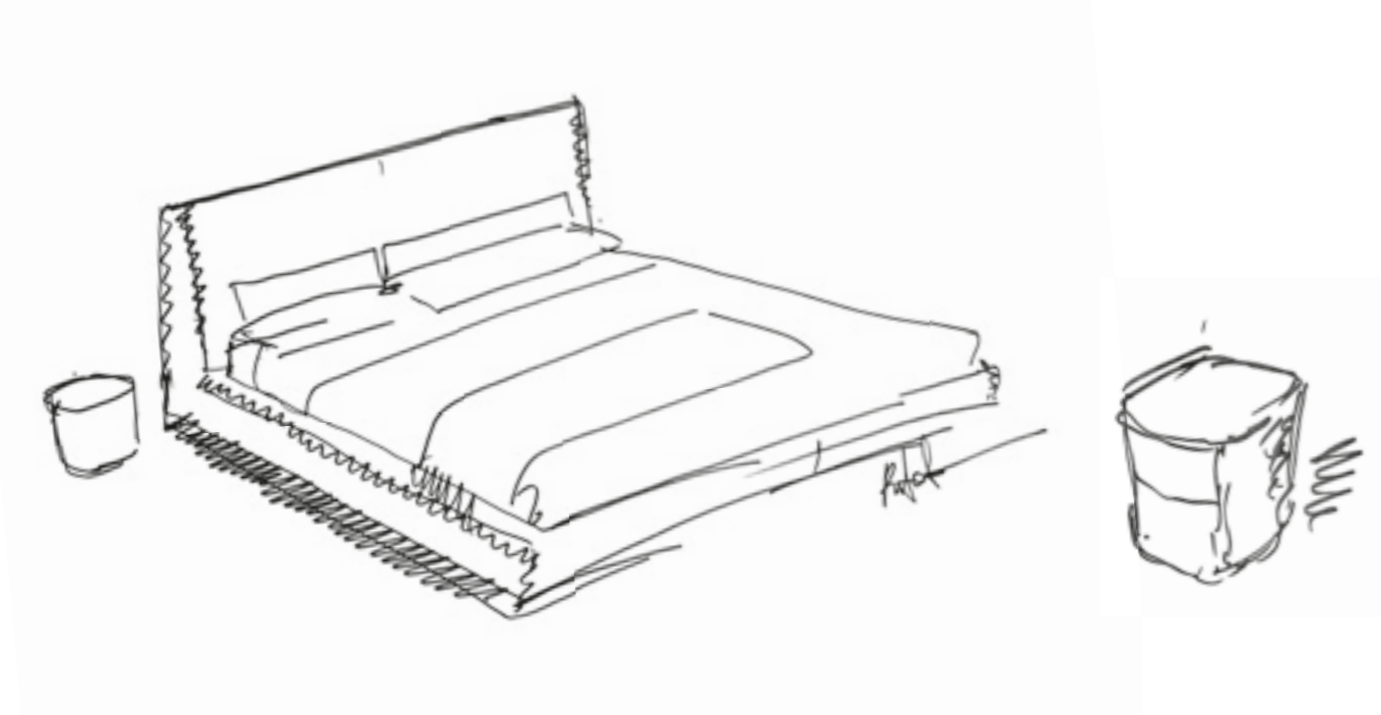

LCT TERRACOTTA 478

HEAT-TREATED OAK

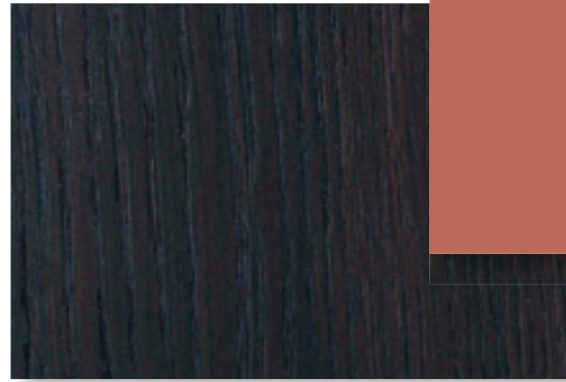

BLACK MARQUINIA  
MARBLE

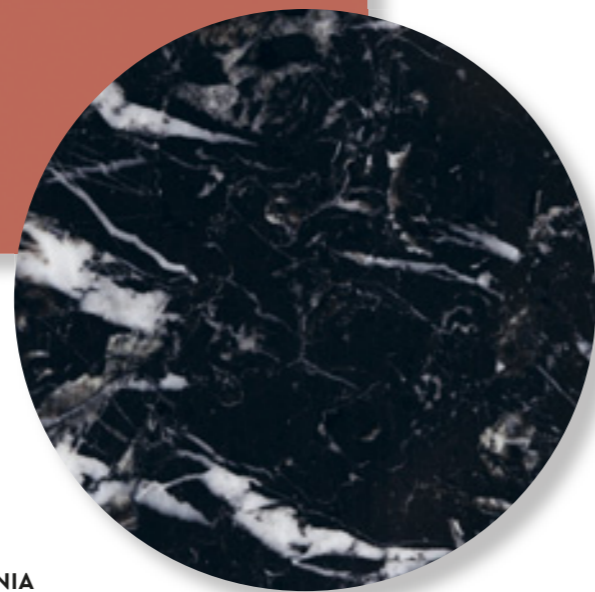

**IT** Un sistema componibile in grado di adattarsi alle esigenze della contemporaneità, un arredo multifunzionale dall'aspetto minimalista. Lina è la consolle che nasce per abitare gli ingressi delle case, introducendo chi vi abita ad un'atmosfera di calore e convivialità.

**EN** A modular system capable of adapting to contemporary needs, a multifunctional furnishing with a minimalist look. Lina is a console that was created to be placed at the entrance of a home, giving an immediate impact of warmth and conviviality.

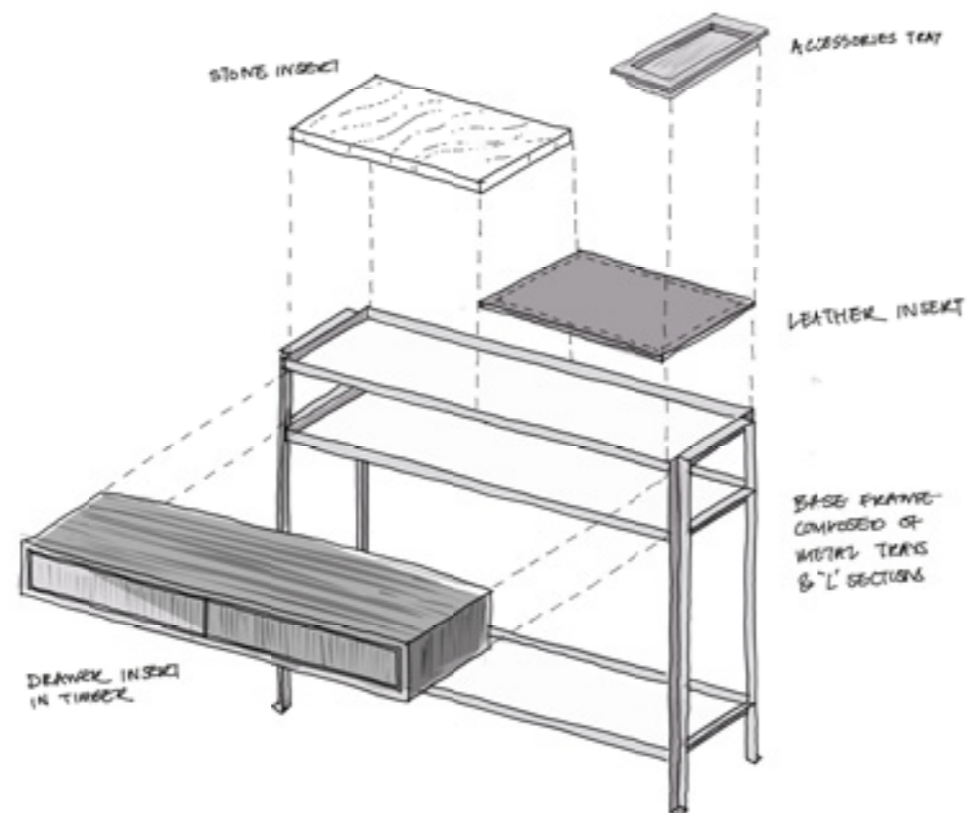

# LINA

## Console





**IT** Firmata da Squire&Partners, la consolle si presenta con una struttura aerea e un sottile top personalizzabile grazie all'ampia gamma di finiture a catalogo. Disponibile con e senza cassetti, la consolle Lina può essere corredata da una parete attrezzata e uno specchio.

**EN** Designed by Squire&Partners, the console has a light structure and a thin top that can be customised thanks to the wide range of finishes in the catalogue. Available with and without drawers, the Lina console can be equipped with a backwall and mirror.

**IT** Essenziale al primo sguardo, la raffinatezza della sedia e poltroncina Ayra è esaltata nei dettagli sartoriali e nella sinuosa curvatura del sedile, che rende la seduta delicata e armonica. Rivestita in tessuto o pelle, Ayra è proposta con gambe in metallo o nell'inedita versione in frassino tinto rovere.

**EN** Essential at first glance, the elegance of the Ayra chair and armchair is enhanced in the sartorial details and by the sinuous curves of the seat, making it delicate and harmonious. Upholstered in fabric or leather, Ayra is available with metal legs or in the new version in oak-stained ash.

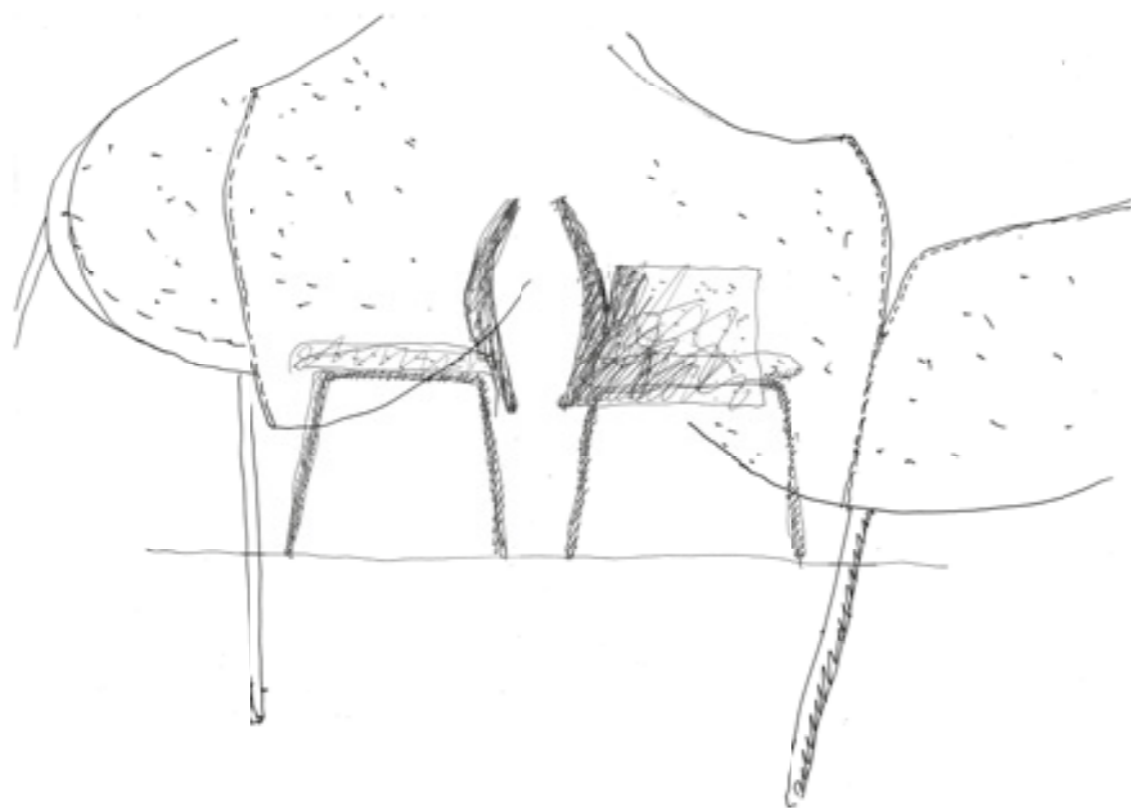

# AYRA

## Chair+Armchair





**IT** Una seduta dal design avvolgente e fortemente contemporanea nelle proporzioni, ideale intorno ad un tavolo da pranzo dalle dimensioni generose. Il suo tratto distintivo risiede nelle linee dello schienale che scendono rispetto alla seduta, creando un movimento inaspettato.

**EN** A seat with an enveloping design and strong contemporary proportions, it is ideal around a generously sized dining table. The distinctive feature lies in the lines of the backrest that descend lower than the seat, creating an unexpected movement.

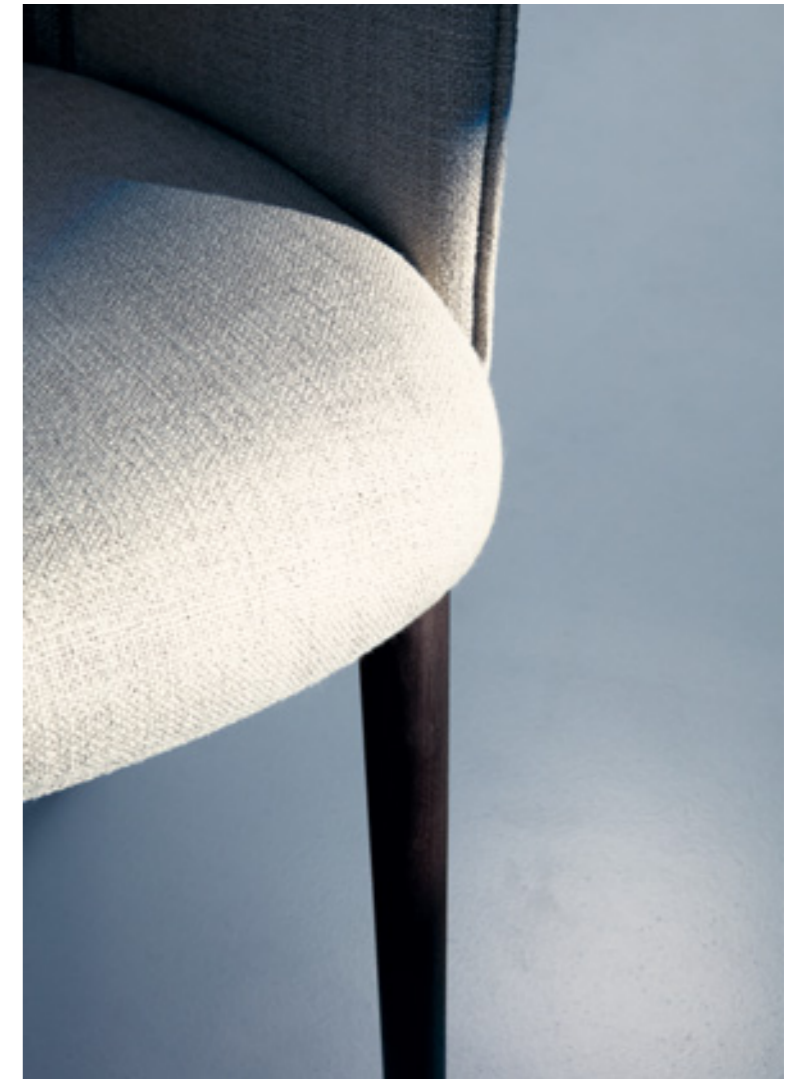

**IT** Drum è un'esplorazione giocosa di forma e funzione. La famiglia di tavolini e pouf firmata da Piero Lissoni si distingue per la particolare struttura in legno cannetato, lavorato a toro in massello di noce canaletto, che dona un inaspettato dinamismo alla zona living. Il tavolino è disponibile sia nella versione rotonda e ovale che in forma quadrata.

**EN** Drum is a playful exploration between form and function. The group of tables and poufs designed by Piero Lissoni stand out for the structure in ribbed wood in solid Canaletto walnut, which gives an unexpected dynamism to the living area. The coffee table is available both in the round and oval version as in the square shape.

# DRUM

Coffee tables+Pouf

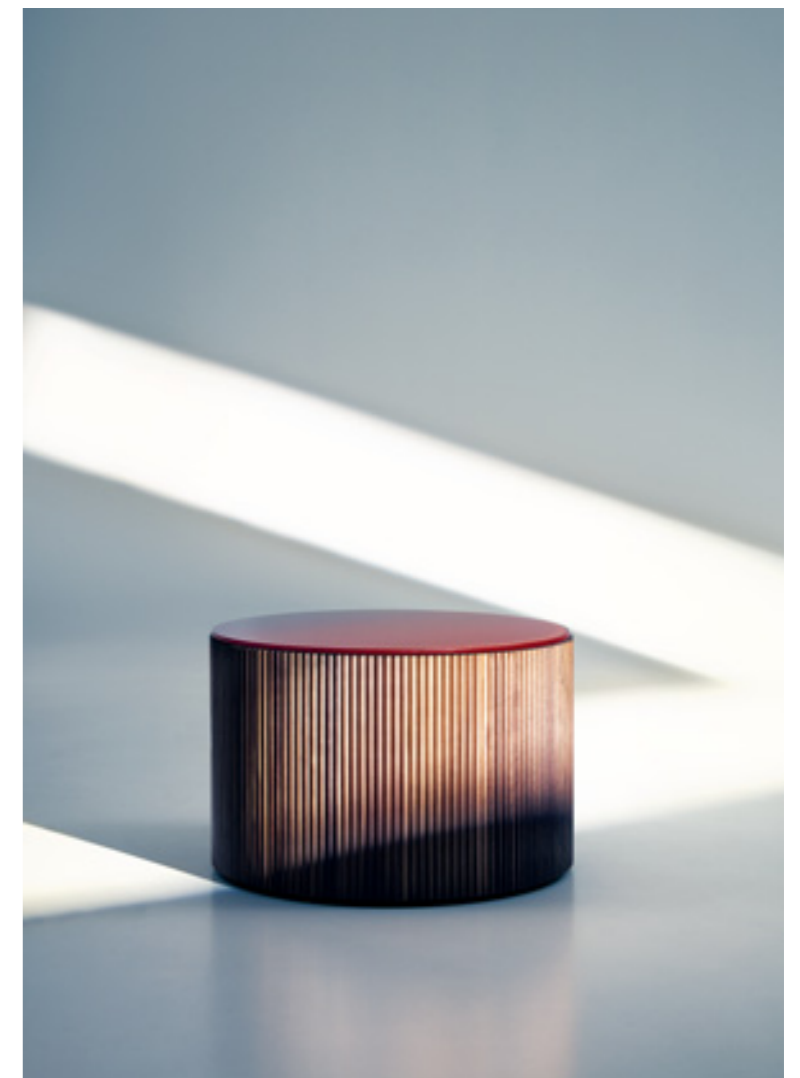
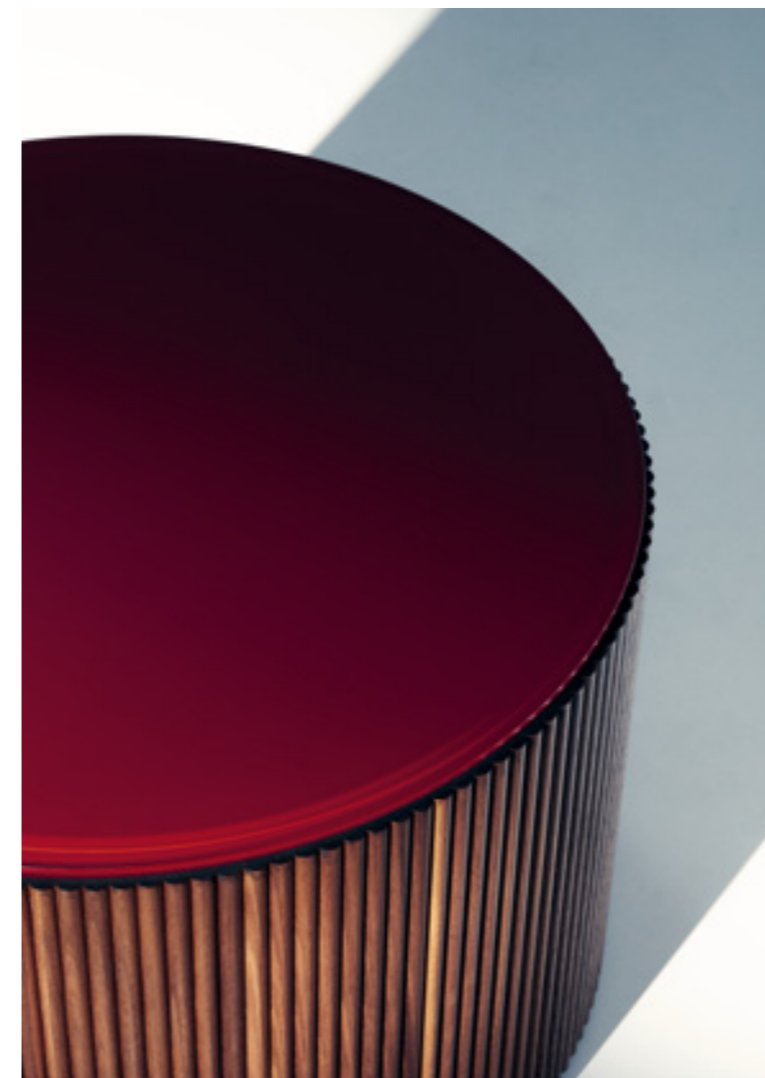
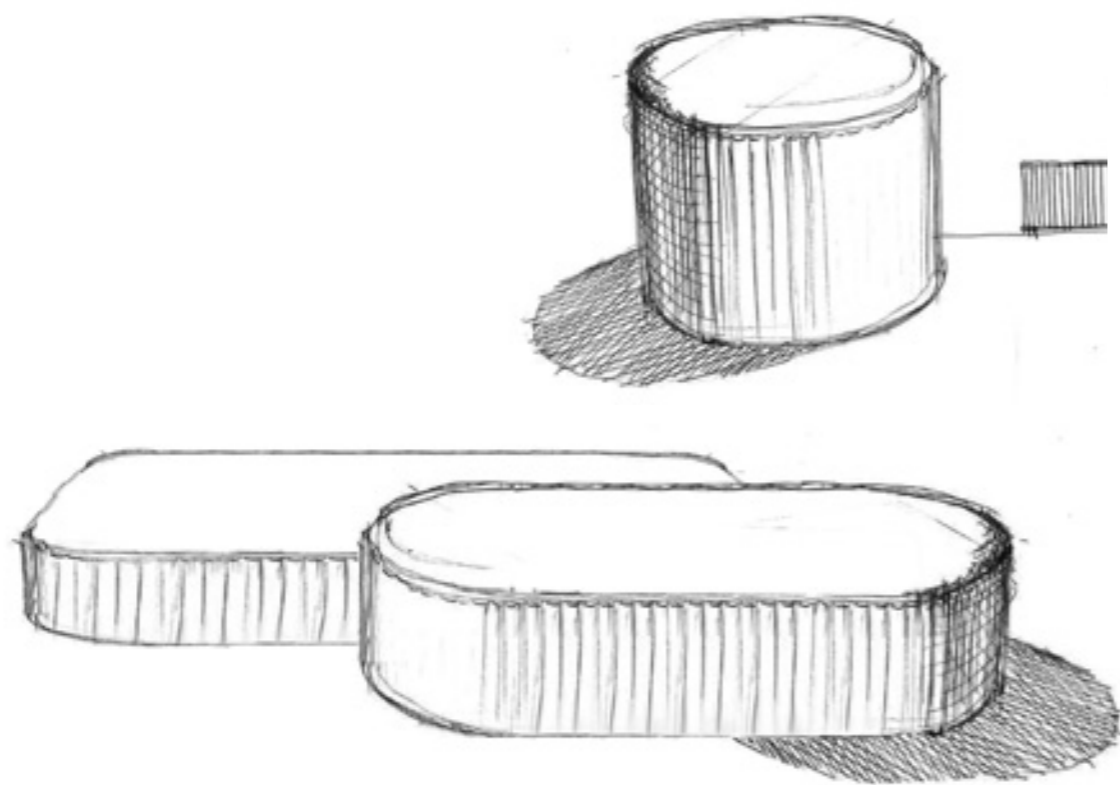

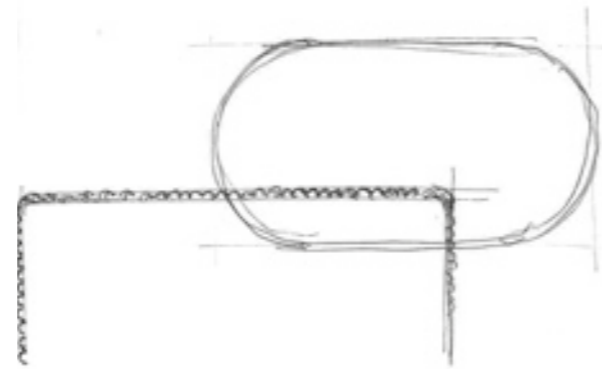

## FINISHINGS Proposals



**IT** Il top del tavolino Drum può essere personalizzato con un piano in vetro retroverniciato, in pietra o in marmo, in tutte le varianti in collezione. Il pouf, disponibile esclusivamente nella versione tonda, eredita la caratteristica struttura in legno, esempio di alta ebanisteria, a cui si aggiunge un morbido cuscino imbottito rivestito in tessuto o pelle.

**EN** The top of the Drum coffee table can be customised in back-painted glass, stone or marble, in all the variants of the collection. The pouf, available exclusively in the round version, inherits the characteristic wooden structure, an example of high craftsmanship, to which a soft padded cushion covered in fabric or leather is added.

NYDA TDC371



PORTORO MARBLE



LACQUERED  
RED GLASS

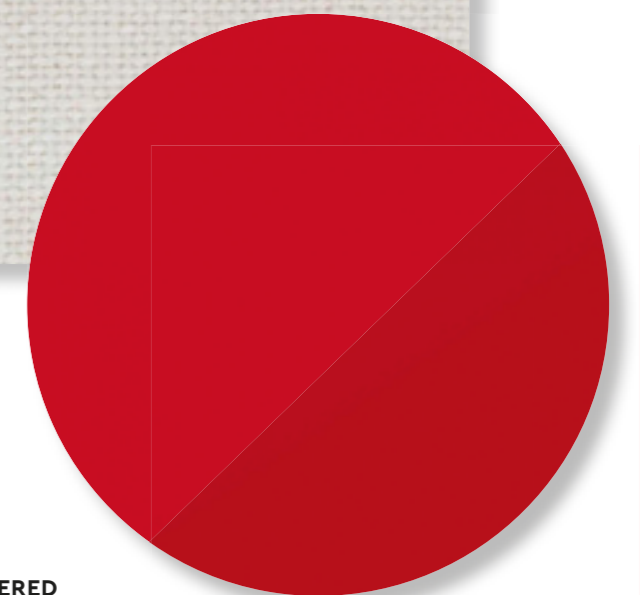



**IT** Si amplia la collezione Niveaux, divano dalle molteplici facce che creano composizioni sempre diverse, in grado di esprimere la sua personalità giovane e fresca e di abitare la zona living con disinvoltura. Ad arricchire il ventaglio di configurazioni del divano, un nuovo modulo ad angolo, dormeuse e chaise-longue per assicurare il massimo comfort.

**EN** The Niveaux collection is growing, a sofa with multiple looks creating ever-changing compositions expressing its young and fresh personality, ideal to be placed in a living area with ease. Enriching the range of sofa configurations, a new corner module, daybed and chaise-longue ensures maximum comfort.

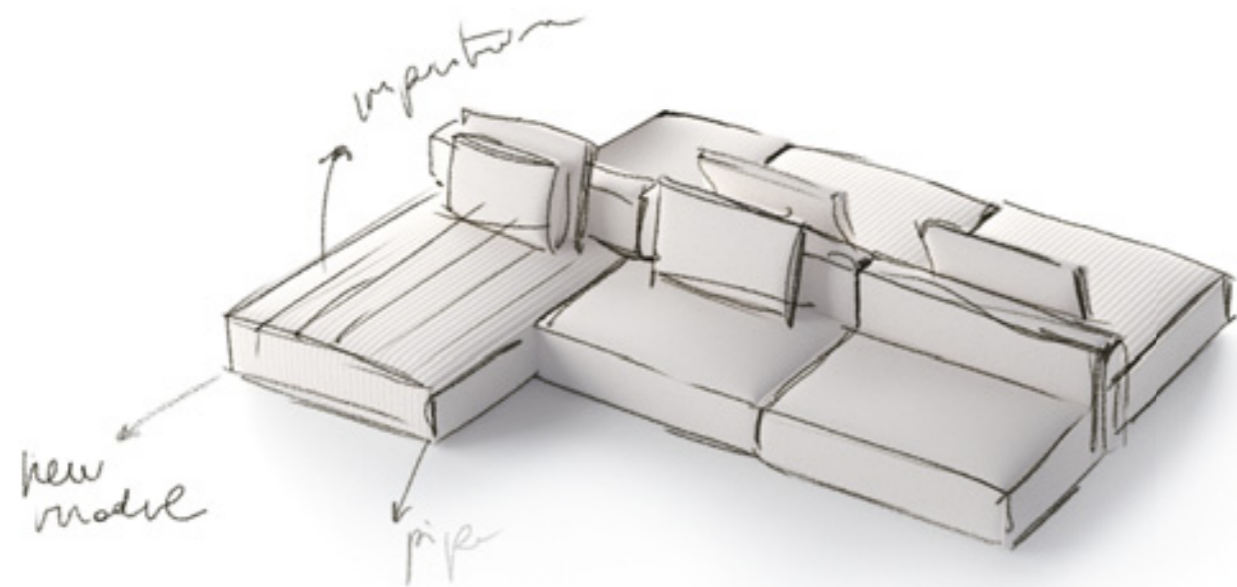

# NIVEAUX

## Sofa



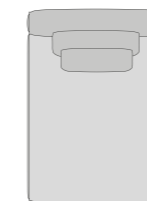
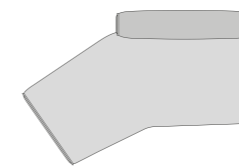
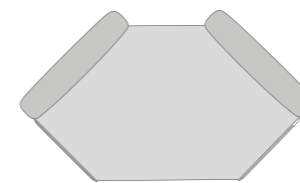
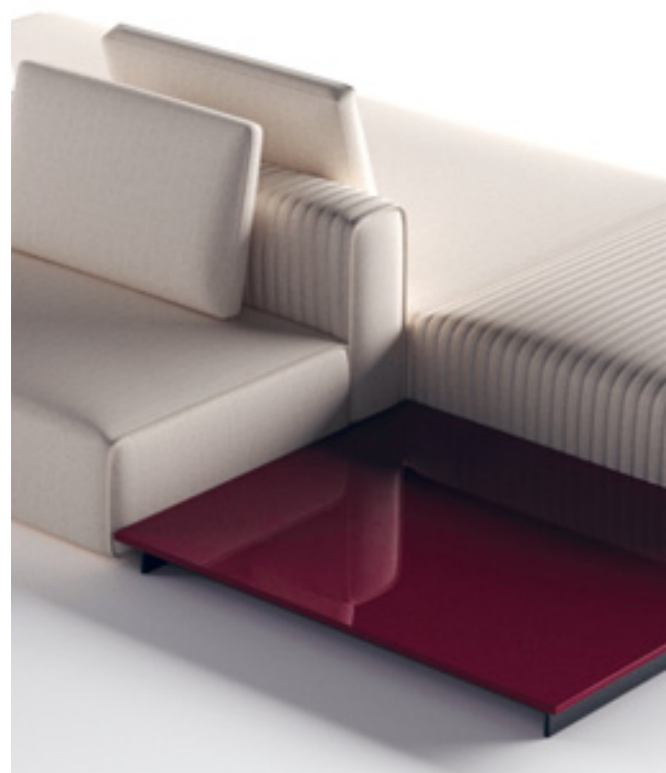

**IT** Ad arricchire la proposta del divano a terra modulare firmato da Federica Biasi, una nuova impuntura che impreziosisce la seduta, nel segno di una raffinata manualità.

**EN** Enriching the proposals of the modular floor sofa designed by Federica Biasi, a new stitching that embellishes the seat, signifying true craftsmanship.



**IT** Lema rivoluziona ancora una volta il concetto di cabina armadio dando vita a VentiTre: un sistema modulare ad alta personalizzazione, realizzato con materiali completamente riciclabili. VentiTre lancia una nuova sfida in termini di scelta grazie ad una vasta gamma di finiture, cromie e materiali che personalizzano l'ambiente creando un'atmosfera unica.

**EN** Lema once again revolutionizes the concept of the walk-in wardrobe, giving life to VentiTre: a highly customized modular system, made with completely recyclable materials. VentiTre launches a new challenge in terms of personalisation thanks to a vast range of finishes, colours and materials that personalise the space by creating a unique atmosphere.

# VentiTre

## Walk-in wardrobe

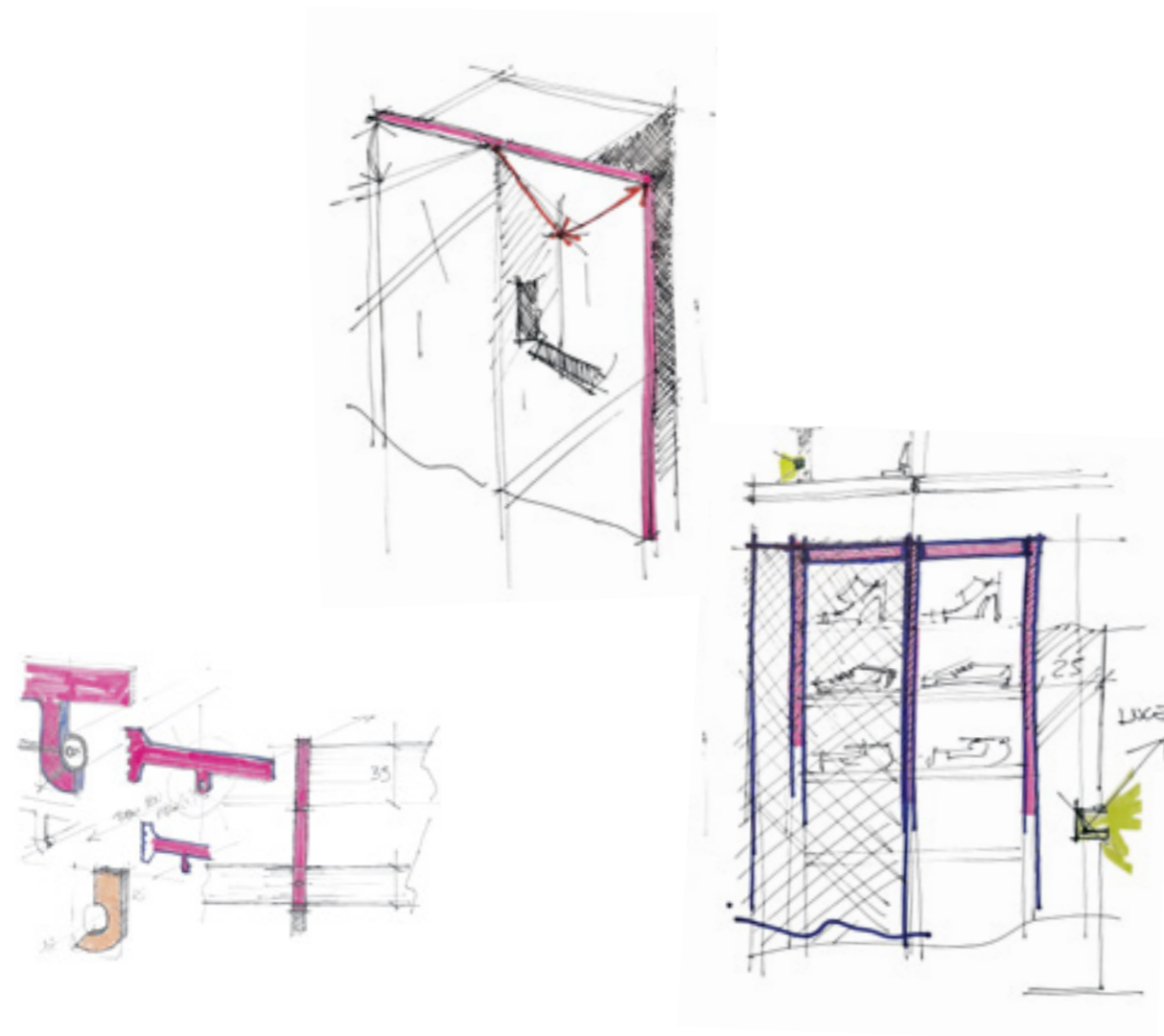

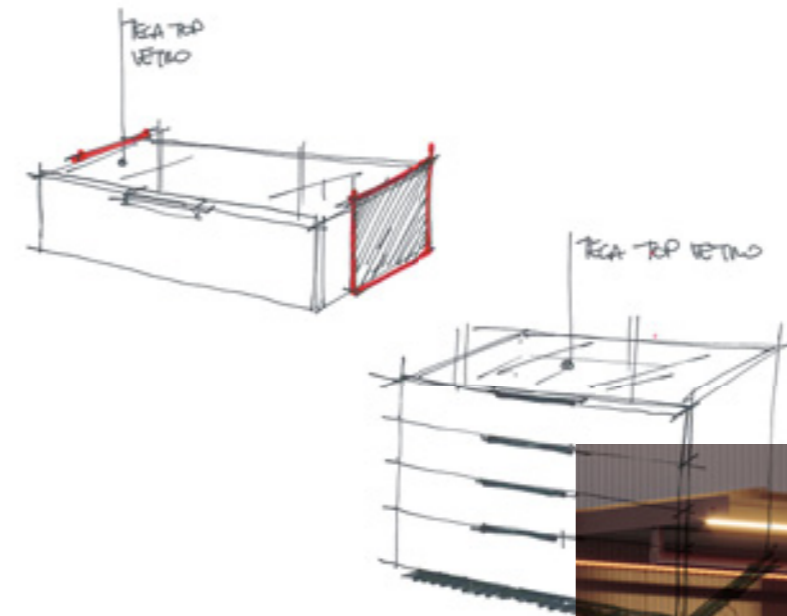
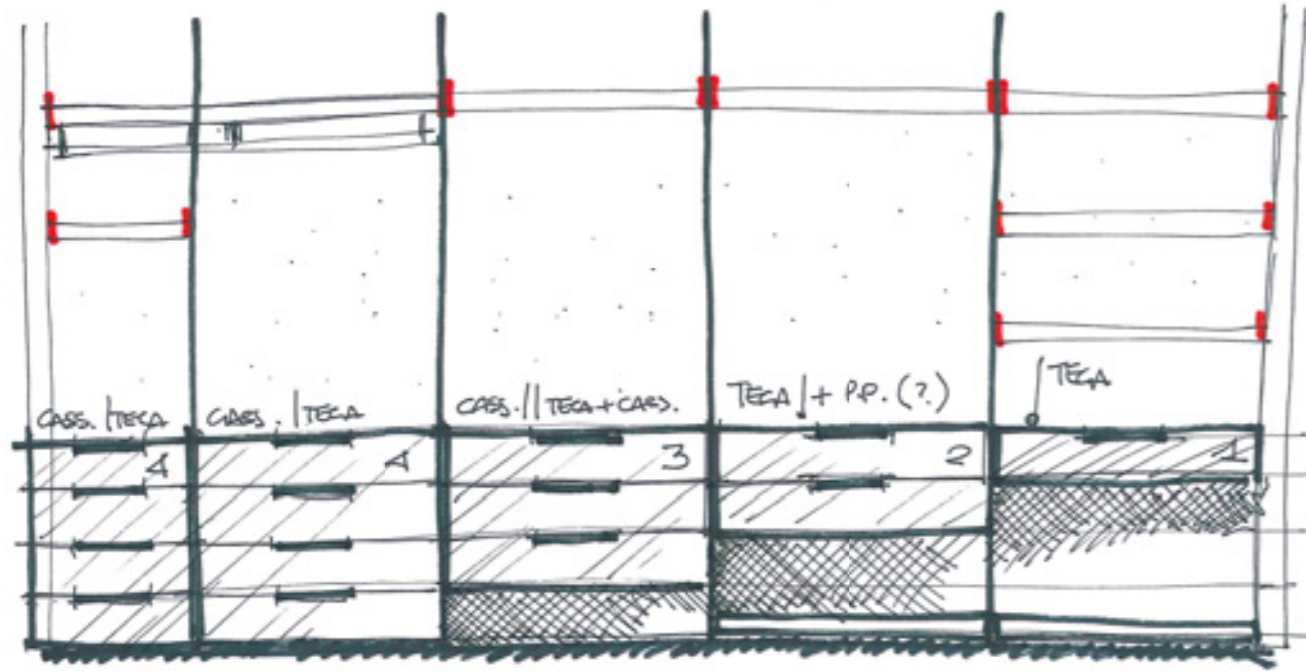

**IT** Un progetto sartoriale che realizza i desideri di clienti e progettisti. Nella versione priva di pannelli a muro, VentiTre si presenta come un sistema semplice, intelligente e versatile che delinea l'ambiente con leggerezza. Per una proposta progettuale più complessa, VentiTre rende il pannello protagonista, elevandolo a tela sulla quale dare vita a una cabina armadio ricamata su misura della propria personalità.

**EN** A sartorial project for all the design wishes of both designer and end-clients. In the version without wall panels, VentiTre presents itself as a simple, intelligent and versatile system that outlines the space where it's placed with lightness. For a more complex design proposal, VentiTre makes the panel the protagonist, elevating it to a canvas on which to create a custom walk-in wardrobe able to its owner's personality.

**IT** Un'anta che fa della diversità materica e cromatica il suo punto di forza. Lena è l'ultima proposta firmata da Piero Lissoni, un'anta fortemente decorativa che svela il suo carattere audace nella combinazione tra finiture diverse. La maniglia, scompare nell'architettura, diventando l'elemento che delinea i confini dei diversi materiali.

**EN** A door that makes the material and chromatic diversity its strong point. Lena is the latest design by Piero Lissoni, a highly decorative door that reveals its bold character through the combination of different finishes. The handle disappears in the design, becoming the element that defines the boundaries of the different materials.

# LENA

## Wardrobe

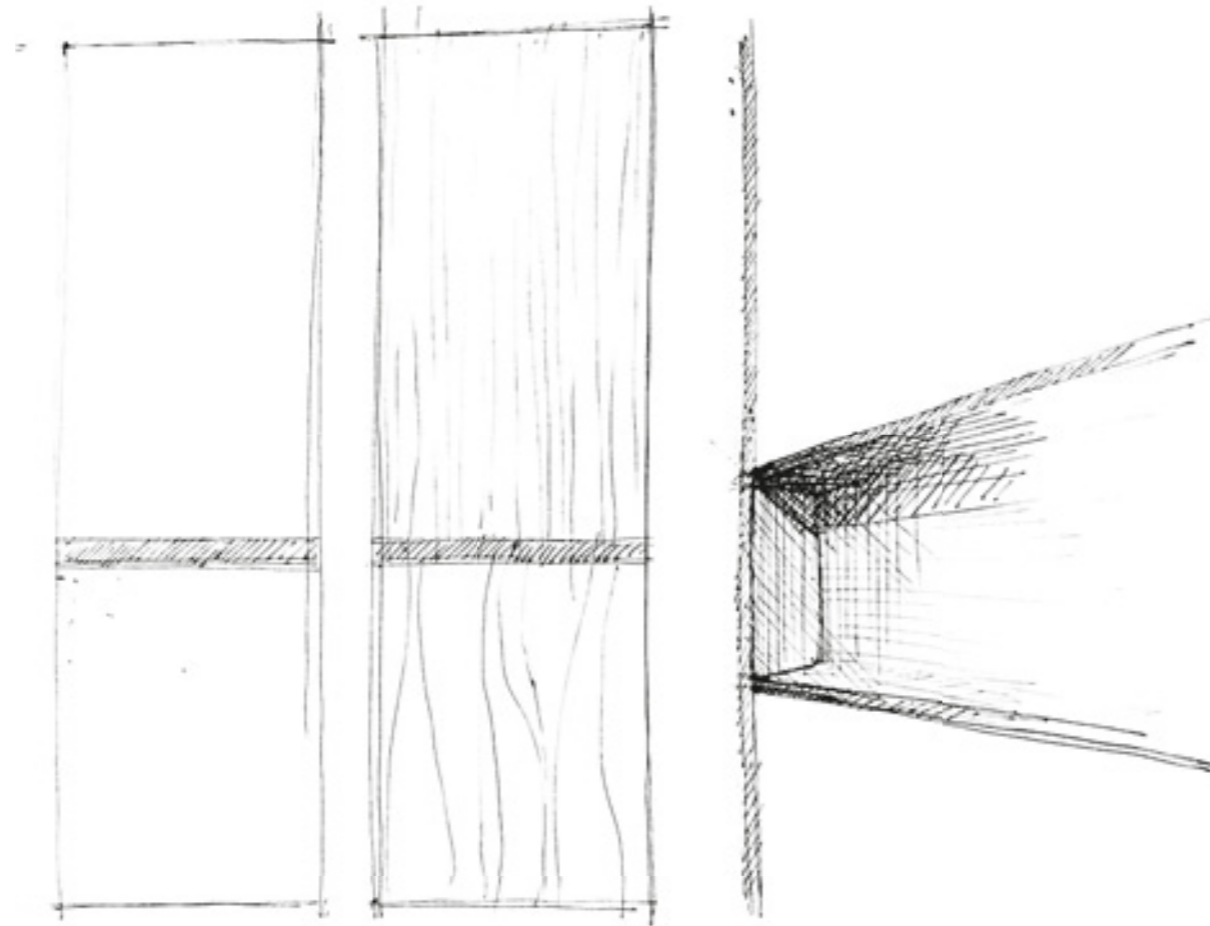

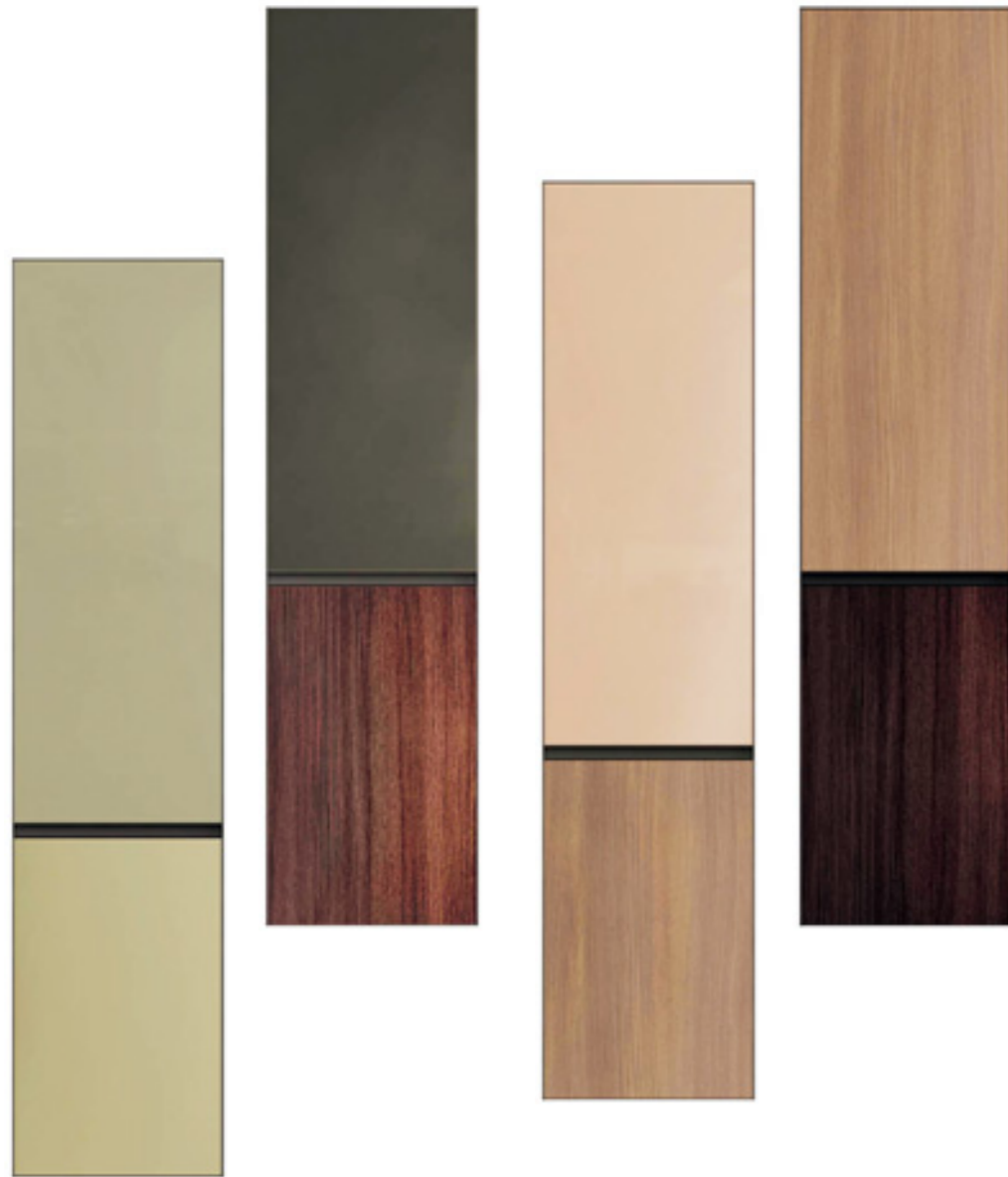

**IT** La maniglia diventa un segno grafico deciso che delinea due colori e due materiali diversi. Il gioco di contrasti diventa la cifra stilistica di Lena, un armadio dal forte carattere espressivo e audace.

**EN** The handle becomes a decisive graphic design that outlines two colours and two materials. The game of contrasts is the stylistic feature of Lena, a wardrobe with a strong expressive and audacious character.

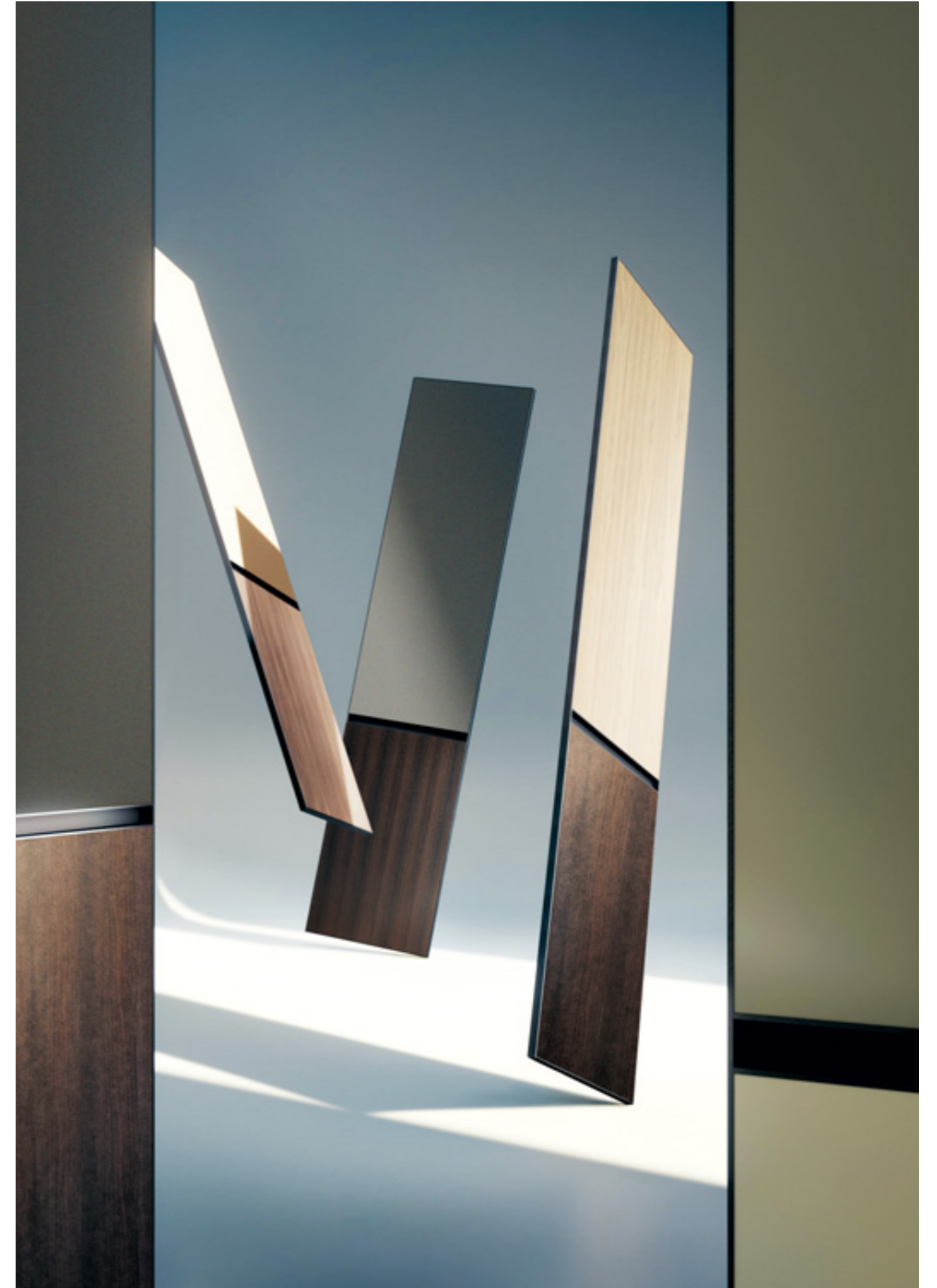

PROJECT LISSONI GRAPHX  
PHOTO THOMAS PAGANI  
GRAPHIC 3D KOPERATIVESTUDIO  
TEXT R+W  
TRANSLATION LEMA  
REPRO+PRINT OGM, 2023

LEMA S.P.A.  
22040 ALZATE BRIANZA  
COMO — ITALIA  
STRADA STATALE BRIANTEA N° 2  
T. +39 031 630 990  
LEMAMOBILI.COM

关注LEMA微信公众号  
Follow LEMA WeChat account



公众号 ID : LemaOfficial

关注LEMA小红书官方号  
Follow LEMA RedBook account

