

codice prodotto: **BOMOAN**

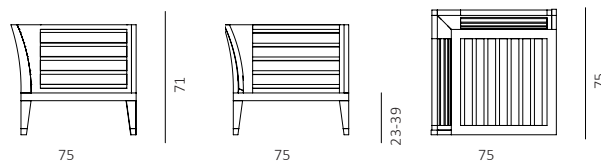

Modulo angolo in mogano effetto lucido

CONDIZIONI DI UTILIZZO

H

Hard Conditions: locali ad alta frequentazione (bar, pub)

M

Medium Conditions: utilizzo HORECA

MATERIALI E FINITURE

Telaio in mogano



Lucido

TIPOLOGIA DI PRODOTTO

Assemblato

IMBALLO

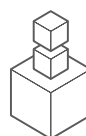

1 pz



30 Kg

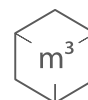

0,600 m³



87 x 87 x 80 cm

codice prodotto: **BOMODI2P**

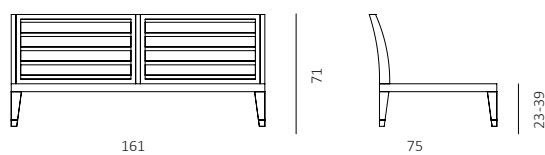
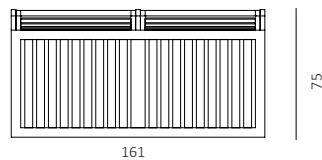

Divano 2 posti in mogano effetto lucido

CONDIZIONI DI UTILIZZO

H

Hard Conditions: locali ad alta frequentazione (bar, pub)

M

Medium Conditions: utilizzo HORECA

MATERIALI E FINITURE

Telaio in mogano



Lucido

TIPOLOGIA DI PRODOTTO

Da assemblare

IMBALLO

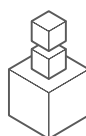

1 pz



38 Kg

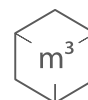

0,550 m³



170 x 90 x 36 cm

codice prodotto: **BOMODI3P**

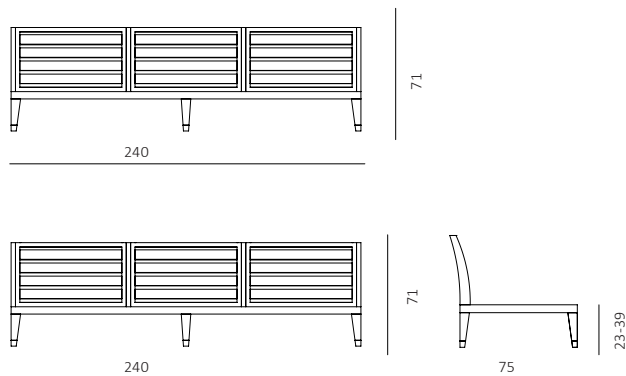

Divano 3 posti in mogano effetto lucido



CONDIZIONI DI UTILIZZO

H

Hard Conditions: locali ad alta frequentazione (bar, pub)

M

Medium Conditions: utilizzo HORECA

MATERIALI E FINITURE

Telaio in mogano



Lucido

TIPOLOGIA DI PRODOTTO

Da assemblare

IMBALLO

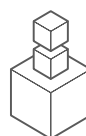

1 pz



59 Kg

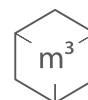

0,777 m³



248 x 90 x 36 cm

codice prodotto: **BOMOSP**

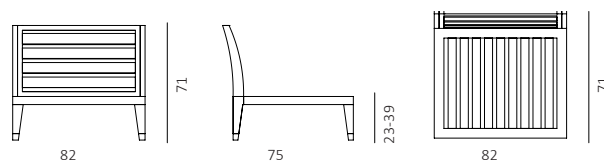

Modulo angolo in mogano effetto lucido

CONDIZIONI DI UTILIZZO

H

Hard Conditions: locali ad alta frequentazione (bar, pub)

M

Medium Conditions: utilizzo HORECA

MATERIALI E FINITURE

Telaio in mogano



Lucido

TIPOLOGIA DI PRODOTTO

Da assemblare

IMBALLO

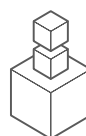

1 pz



23 Kg



0,295 m³



86 x 86 x 40 cm

codice prodotto: **BOMOLES**

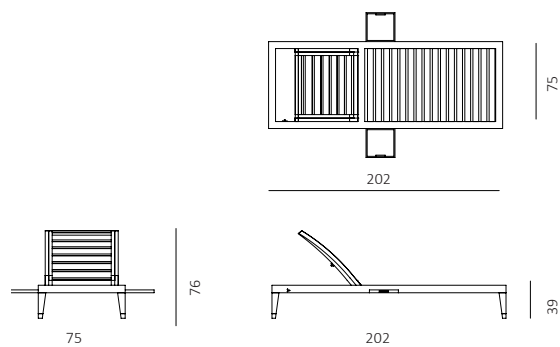

Letto in mogano effetto lucido

CONDIZIONI DI UTILIZZO

H Hard Conditions: locali ad alta frequentazione (bar, pub)

M Medium Conditions: utilizzo HORECA

MATERIALI E FINITURE

Telaio in mogano



Lucido

TIPOLOGIA DI PRODOTTO

Assemblato

IMBALLO

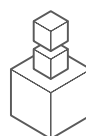

1 pz



38 Kg

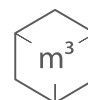

0,592 m³



210 x 83 x 34 cm

codice prodotto: **BOMOLED**

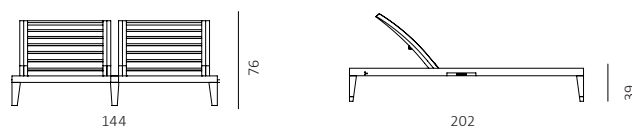

Lettino doppio in mogano effetto lucido

CONDIZIONI DI UTILIZZO

H

Hard Conditions: locali ad alta frequentazione (bar, pub)

M

Medium Conditions: utilizzo HORECA

MATERIALI E FINITURE

Telaio in mogano



Lucido

TIPOLOGIA DI PRODOTTO

Assemblato

IMBALLO

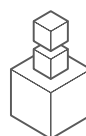

1 pz



48 Kg

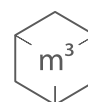

1,185 m³



210 x 166 x 34 cm

codice prodotto: **BOMOTAVQ**

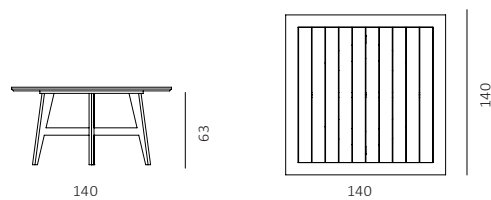

Tavolo quadrato in mogano effetto lucido

CONDIZIONI DI UTILIZZO

H

Hard Conditions: locali ad alta frequentazione (bar, pub)

M

Medium Conditions: utilizzo HORECA

MATERIALI E FINITURE

Telaio in mogano



Lucido

TIPOLOGIA DI PRODOTTO

Da assemblare

IMBALLO



2 pz



96 Kg

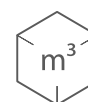

0,758 m³



140 x 140 x 67 cm

codice prodotto: **BOMOTB**

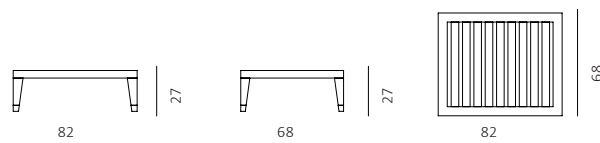

Coffee table rettangolare in mogano effetto lucido

CONDIZIONI DI UTILIZZO

H

Hard Conditions: locali ad alta frequentazione (bar, pub)

M

Medium Conditions: utilizzo HORECA

MATERIALI E FINITURE

Telaio in mogano



Lucido

TIPOLOGIA DI PRODOTTO

Assemblato

IMBALLO

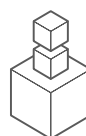

1 pz



12 Kg

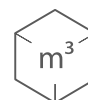

0,295 m³



86 x 86 x 40 cm

CURA E MANUTENZIONE

MOGANO

Per la pulizia del mogano passare delicatamente un pennello a setole morbide per pulire la superficie. Diluire in una bacinella d'acqua tiepida un cucchiaino di sapone liquido neutro, bagnare e strizzare un panno morbido in questa soluzione e lavare bene il legno in ogni sua parte. Pulire eventuali aloni difficili da rimuovere con ovatta inumidita in acqua e aceto bianco. Asciugare accuratamente tutte le superfici appena pulite.

CARE AND MAINTENANCE

MAHOGANY

To clean the mahogany firstly use a brush with soft bristles to clean the surface. Dilute a spoonful of neutral liquid soap in a bowl of warm water; wet and wring a soft cloth in this solution and clean all parts of the wood thoroughly. Remove any difficult stains with cotton wool swabs moistened with water and white vinegar. Dry thoroughly all cleaned surfaces.