

codice prodotto: **WELAND90**

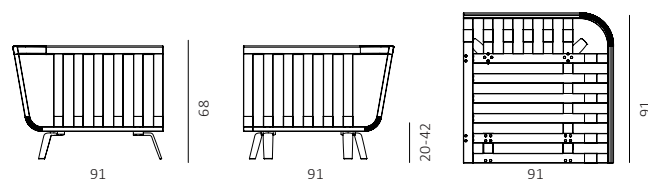

Modulo angolo destro in teak con piedini in fusione di alluminio

CONDIZIONI DI UTILIZZO

- H** Hard Conditions: locali ad alta frequentazione (bar, pub)
- SG** Seaside
- M** Medium Conditions: utilizzo HORECA

MATERIALI E FINITURE

Telaio in teak



Teak

TIPOLOGIA DI PRODOTTO

Da Assemblare

IMBALLO

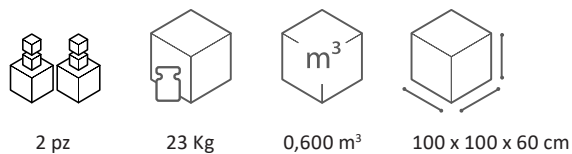

codice prodotto: **WELANS90**

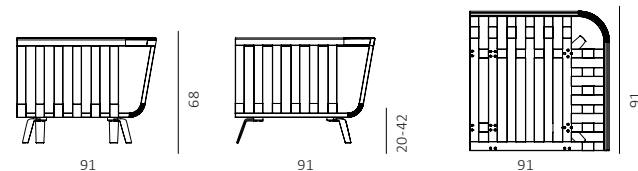

Modulo angolo sinistro in teak con piedini in fusione di alluminio

CONDIZIONI DI UTILIZZO

H

Hard Conditions: locali ad alta frequentazione (bar, pub)

SG

Seaside

M

Medium Conditions: utilizzo HORECA

MATERIALI E FINITURE

Telaio in teak



Teak

TIPOLOGIA DI PRODOTTO

Da Assemblare

CERTIFICAZIONI

IMBALLO



2 pz



23 Kg

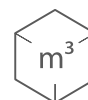

0,600 m³



100 x 100 x 60 cm

codice prodotto: **WELAND130**

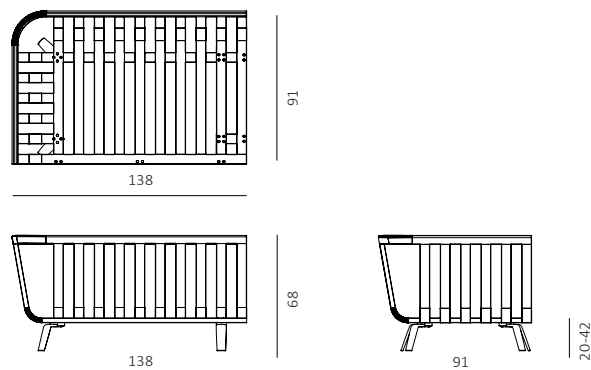

Modulo angolo destro grande in teak con piedini in fusione di alluminio

CONDIZIONI DI UTILIZZO

- H** Hard Conditions: locali ad alta frequentazione (bar, pub)
- SG** Seaside
- M** Medium Conditions: utilizzo HORECA

MATERIALI E FINITURE

Telaio in teak



Teak

TIPOLOGIA DI PRODOTTO

Da Assemblare

IMBALLO

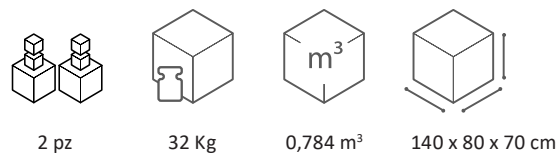

codice prodotto: **WELANS130**

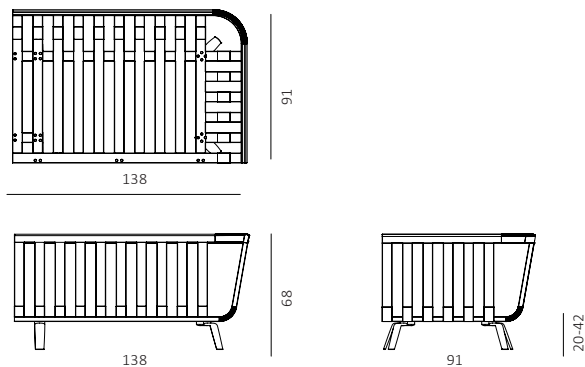

Modulo angolo sinistro grande in teak con piedini in fusione di alluminio

CONDIZIONI DI UTILIZZO

- H** Hard Conditions: locali ad alta frequentazione (bar, pub)
- SG** Seaside
- M** Medium Conditions: utilizzo HORECA

MATERIALI E FINITURE

Telaio in teak



Teak

TIPOLOGIA DI PRODOTTO

Da Assemblare

IMBALLO

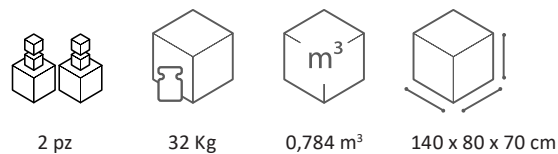

2 pz

32 Kg

0,784 m³

140 x 80 x 70 cm

codice prodotto: **WELPO**

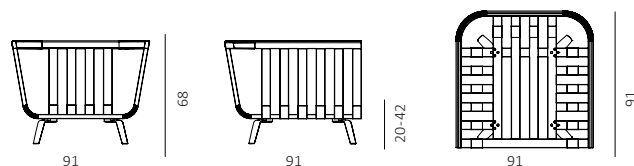

Modulo angolo destro grande in teak con piedini in fusione di alluminio

CONDIZIONI DI UTILIZZO

- H** Hard Conditions: locali ad alta frequentazione (bar, pub)
- SG** Seaside
- M** Medium Conditions: utilizzo HORECA

MATERIALI E FINITURE

Telaio in teak



Teak

TIPOLOGIA DI PRODOTTO

Da Assemblare

IMBALLO

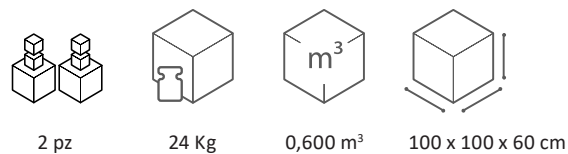

codice prodotto: **WELPU**

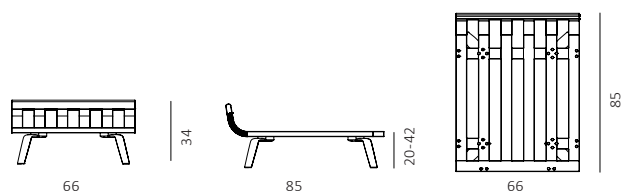

Pouf in teak con piedini in fusione di alluminio

CONDIZIONI DI UTILIZZO

- H** Hard Conditions: locali ad alta frequentazione (bar, pub)
- SG** Seaside
- M** Medium Conditions: utilizzo HORECA

MATERIALI E FINITURE

Telaio in teak



Teak

TIPOLOGIA DI PRODOTTO

Da Assemblare

IMBALLO

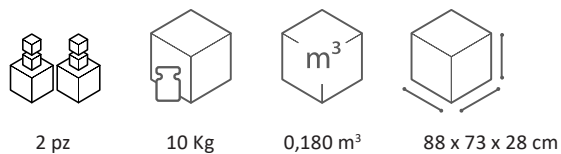

codice prodotto: **WELSPA**

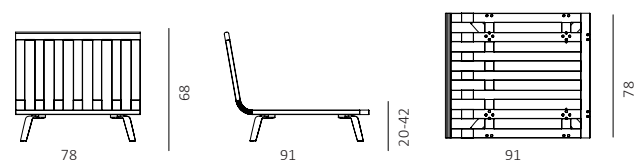

Modulo spalla in teak con piedini in fusione di alluminio

CONDIZIONI DI UTILIZZO

H

Hard Conditions: locali ad alta frequentazione (bar, pub)

SG

Seaside

M

Medium Conditions: utilizzo HORECA

MATERIALI E FINITURE

Telaio in teak



Teak

TIPOLOGIA DI PRODOTTO

Da Assemblare

CERTIFICAZIONI

IMBALLO



2 pz



15 Kg

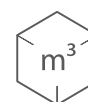

0,432 m³



90 x 80 x 60 cm

codice prodotto: **WELCAND90**

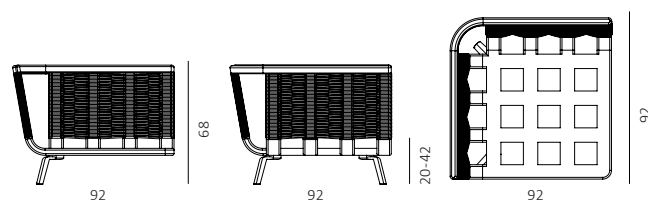

Modulo angolo destro in teak con piedini in fusione di alluminio, intreccio di corda in polipropilene

CONDIZIONI DI UTILIZZO

- H** Hard Conditions: locali ad alta frequentazione (bar, pub)
- SG** Seaside
- M** Medium Conditions: utilizzo HORECA

MATERIALI E FINITURE

Telaio in teak



Teak

Corda in polipropilene



Beige Melange

TIPOLOGIA DI PRODOTTO

Da Assemblare

IMBALLO

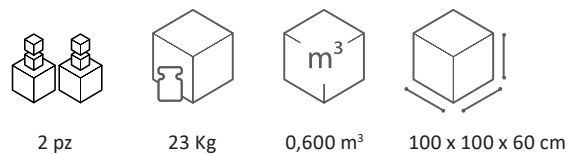

codice prodotto: **WELCANS90**

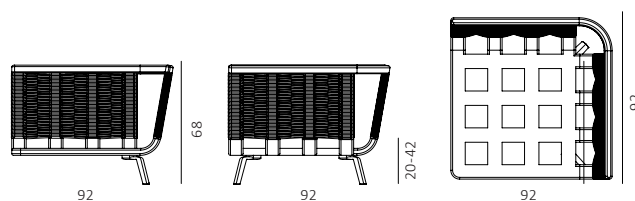

Modulo angolo sinistro in teak con piedini in fusione di alluminio, intreccio di corda in polipropilene

CONDIZIONI DI UTILIZZO

H

Hard Conditions: locali ad alta frequentazione (bar, pub)

SG

Seaside

M

Medium Conditions: utilizzo HORECA

MATERIALI E FINITURE

Telaio in teak



Teak

Corda in polipropilene



Beige Melange

TIPOLOGIA DI PRODOTTO

Da Assemblare

CERTIFICAZIONI

IMBALLO



2 pz



23 Kg

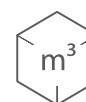

0,600 m³



100 x 100 x 60 cm

codice prodotto: **WELCAND130**

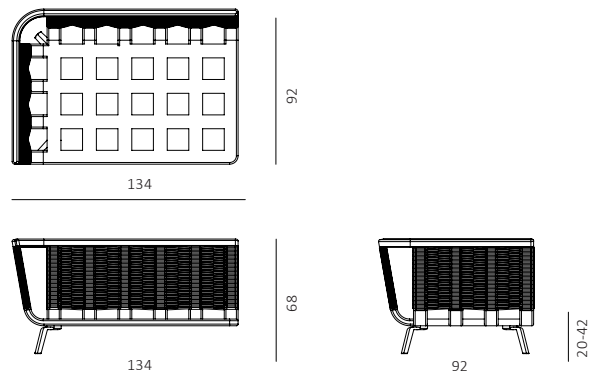

Modulo angolo destro grande in teak con piedini in fusione di alluminio, intreccio di corda in polipropilene

CONDIZIONI DI UTILIZZO

- H** Hard Conditions: locali ad alta frequentazione (bar, pub)
- SG** Seaside
- M** Medium Conditions: utilizzo HORECA

MATERIALI E FINITURE

Telaio in teak



Teak

Corda in polipropilene



Beige Melange

TIPOLOGIA DI PRODOTTO

Da Assemblare

IMBALLO

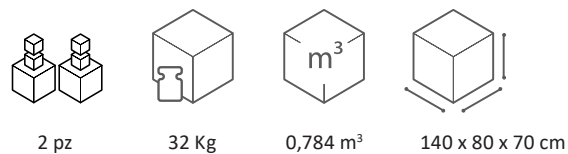

codice prodotto: **WELCANS130**

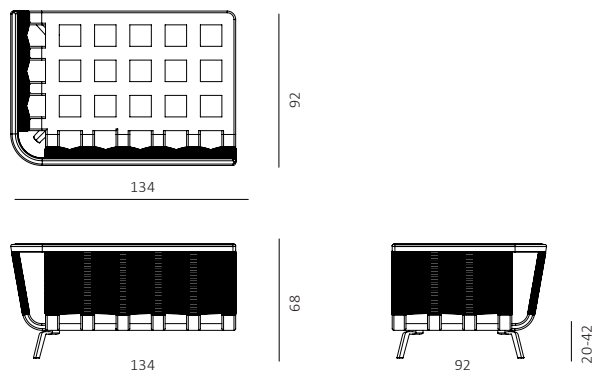

Modulo angolo sinistro grande in teak con piedini in fusione di alluminio, intreccio di corda in polipropilene

CONDIZIONI DI UTILIZZO

- H** Hard Conditions: locali ad alta frequentazione (bar, pub)
- SG** Seaside
- M** Medium Conditions: utilizzo HORECA

MATERIALI E FINITURE

Telaio in teak



Teak

Corda in polipropilene



Beige Melange

TIPOLOGIA DI PRODOTTO

Da Assemblare

IMBALLO

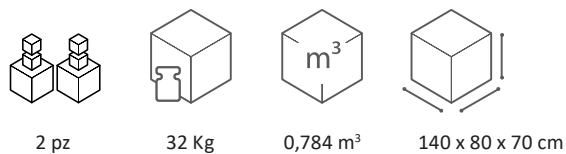

codice prodotto: **WELCSPA**

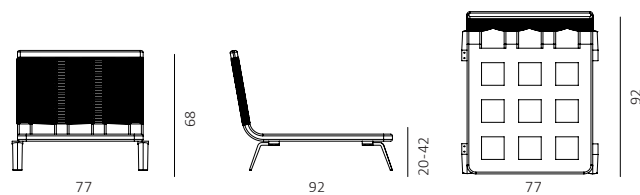

Modulo spalla in teak con piedini in fusione di alluminio, intreccio di corda in polipropilene

CONDIZIONI DI UTILIZZO

- H** Hard Conditions: locali ad alta frequentazione (bar, pub)
- SG** Seaside
- M** Medium Conditions: utilizzo HORECA

MATERIALI E FINITURE

Telaio in teak



Teak

Corda in polipropilene



Beige Melange

TIPOLOGIA DI PRODOTTO

Da Assemblare

IMBALLO

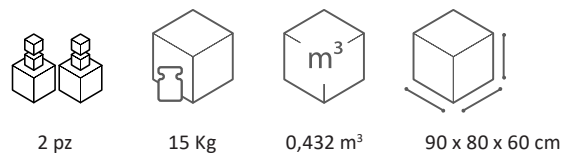



codice prodotto: **WELCPO**

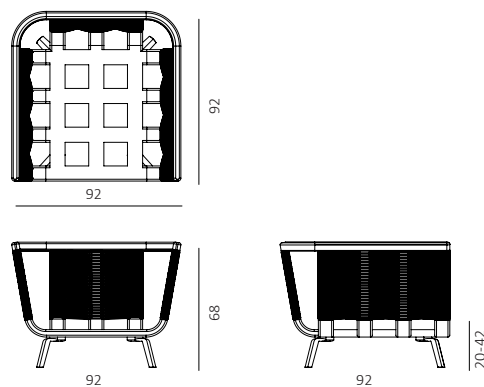

Poltrona in teak con piedini in fusione di alluminio, intreccio di corda in polipropilene

CONDIZIONI DI UTILIZZO

H

Hard Conditions: locali ad alta frequentazione (bar, pub)

SG

Seaside

M

Medium Conditions: utilizzo HORECA

MATERIALI E FINITURE

Telaio in teak



Teak

Corda in polipropilene



Beige Melange

TIPOLOGIA DI PRODOTTO

Da Assemblare

IMBALLO



2 pz



24 Kg

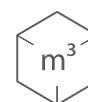

0,600 m³



100 x 100 x 60 cm

codice prodotto: **WELTABQ**

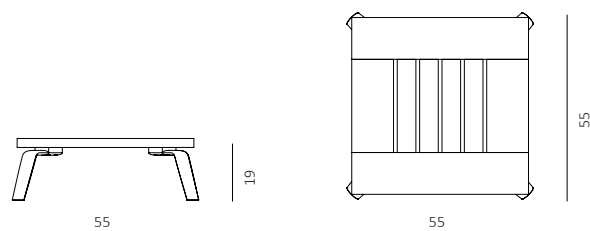

Tavolo basso quadrato in teak con piedini in fusione di alluminio

CONDIZIONI DI UTILIZZO

- H** Hard Conditions: locali ad alta frequentazione (bar, pub)
- SG** Seaside
- M** Medium Conditions: utilizzo HORECA

MATERIALI E FINITURE

Telaio in teak



Teak

TIPOLOGIA DI PRODOTTO

Da Assemblare

CERTIFICAZIONI

IMBALLO

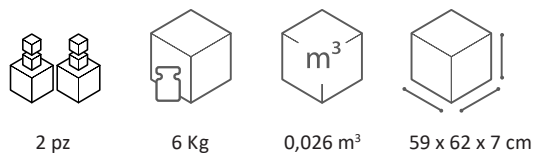

codice prodotto: **WELTABR**

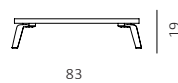
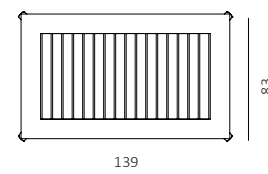

Tavolo basso rettangolare in teak con piedini in fusione di alluminio

CONDIZIONI DI UTILIZZO

H

Hard Conditions: locali ad alta frequentazione (bar, pub)

SG

Seaside

M

Medium Conditions: utilizzo HORECA

MATERIALI E FINITURE

Telaio in teak



Teak

TIPOLOGIA DI PRODOTTO

Da Assemblare

CERTIFICAZIONI

IMBALLO



2 pz



18 Kg

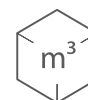

0,090 m³



143 x 90 x 7 cm

CURA E MANUTENZIONE

TEAK

I trattamenti a cui sottoporre il teak annualmente sono di due tipi. Manutenzione Ordinaria (semplice trattamento di pulizia e lucidatura, adatto a mobili non esposti all'esterno o di recente acquisto): lavare il mobile con sapone neutro (sapone di Marsiglia), fare asciugare completamente al sole e applicare qualche goccia di olio di teak, usando un panno di cotone (è sconsigliato l'uso del pennello in quanto creerebbe una patina che impedirebbe al teak di respirare). Manutenzione straordinaria (trattamento di pulizia più profondo, finalizzato al ripristino della colorazione color miele): questo trattamento è consigliato per mobili esposti all'esterno che hanno già raggiunto la tipica colorazione argentea. Passare carta vetrata molto fine per togliere la patina argentata. Lavare con acqua e sapone neutro (sapone di Marsiglia) e lasciare asciugare al sole. Applicare qualche goccia di olio di teak con un pennello di media grandezza e asciugare completamente al sole. Se una volta asciugato dovesse risultare poroso (caratteristica dei pigmenti che compongono l'olio) si consiglia di passare un panno umido su tutto il mobile. Per i mobili appena acquistati si consiglia di passare un panno leggermente umido prima di posizionare i cuscini per togliere un po' di oleosità e prevenire macchie su indumenti o cuscini.

ALLUMINIO

Per mantenere pulito l'alluminio è sufficiente una bacinella con acqua pulita tiepida, un detergente solido o liquido neutro – non abrasivo e non a base di ammoniaca, candeggina o alcool – panni morbidi e una spugna non abrasiva. Utilizzare il panno morbido per asciugare ed evitare la formazione di aloni. Si raccomanda di utilizzare solo acqua tiepida a temperatura massima di 30°. Nel caso di macchie persistenti utilizzare una soluzione di aceto, sapone di Marsiglia neutro o bicarbonato (un cucchiaino di sapone/bicarbonato per ogni litro di acqua).

CORDA

La corda non necessita di un trattamento specifico, ma se si desidera si può provvedere a lavarla periodicamente. Per non danneggiarla durante questa operazione si suggerisce di utilizzare solo acqua pulita e tiepida (temperatura non superiore ai 30°C), un detergente neutro come il sapone di Marsiglia o per i tessuti delicati, ed infine una spazzola sintetica a setole morbide. Una volta terminata la fase di lavaggio si consiglia di far asciugare la corda in un luogo all'ombra, lontano da fonti di calore e possibilmente all'aria aperta.

CARE AND MAINTENANCE

TEAK

There are two types of treatments to be applied annually. Ordinary maintenance (standard cleaning and polishing treatment suitable for recently purchased or indoor furniture): clean the furniture with neutral soap (Marseille soap), let it dry completely under the sun, apply few drops of teak oil using a soft cotton cloth (we do not recommend using a brush as it could create a patina that would prevent the teak from breathing). Deep maintenance (deeper cleansing treatment aimed at restoring the original honey color): this treatment is recommended for outdoor furniture which has reached its typical silver colour. Use very fine sandpaper to remove the natural grey patina, rinse with water and neutral soap (Marseille soap) and let fully dry under the sun. Apply few drops of teak oil with a medium-sized brush and let fully dry again under the sun. After the treatment, should the furniture be porous (characteristic of the oil pigments) we recommend wiping the entire furniture with a damp cloth. For newly purchased furniture we recommend wiping with a slightly damp cloth before placing the cushions to remove natural oils and prevent stains on the clothing and cushions.

ALUMINUM

To maintain the aluminium clean use a basin with warm clean water, a solid or neutral liquid detergent (non-abrasive and not ammonia, bleach or alcohol-based) soft cloths and a non-abrasive sponge. Use a soft cloth to prevent halos. It is recommended to use only lukewarm water (maximum 30°C). In case of persistent stains use a solution of vinegar, neutral Marseille soap or bicarbonate (a spoonful of soap/bicarbonate for each liter of water).

ROPE

Rope does not need any special maintenance, but it can be washed periodically. To avoid damaging the rope during this operation please use clean, lukewarm water (temperature not exceeding 30°C), a neutral detergent such as Marseille soap or one for delicate fabric, and a synthetic brush with soft bristles. Once the rope is cleaned, let it dry away from direct sunlight, possibly in the shadow, away from heat sources and in the open air.